



# **PRINCIPLES OF RADIATION THERAPY**

**Małgorzata Rusiecka**

**Department of Oncology**

**Wrocław University of Medicine**

Clinical Oncology

Computer  
Spatial  
Planning  
System

**Radiation  
Oncology**

Physics of  
Irradiation

Radiobiology

# The arrangement of radiotherapy

- **Curative** : the patient has a probability of long-term survival after adequate therapy, even if the chance is low
- **Palliative** : there are some symptoms that produce discomfort or other conditions that may impair the comfort or self-sufficiency of the patients required treatment.

# The prescription of irradiation is based on the following principles

- Staging - the full extend of the tumor.
- Pathomorphology - pathologic characteristics of the disease including potential areas of spread.
- Definition of goal of therapy.
- The choice of appropriate treatment modalities (irradiation alone or combined with other methods).

# **The prescription of irradiation is based on the following principles**

- The assessment of tolerance to treatment, tumor response and the normal tissues status.
- Creation of the patient's general condition opinion.
- Treatment planning - selection of the optimal dose and volume of irradiation according to anatomic location, histologic type, stage potential nodal spread and others.

# Duties of radiation oncologist (1):

- examine the patient personally
- review the microscopic material
- perform examinations and take a biopsy
- consider the plan of treatment
- suggest the treatment plan to referring physician and to the patient

## Duties of radiation oncologist (2):

- clinical investigation during the course of treatment
- formulate and independent opinion regarding diagnosis and advisable therapy
- direct any additional medication that may be necessary

A Venn diagram with three overlapping circles on a dark red background. The left circle is blue with a yellow border and contains the text 'External beam irradiation'. The middle circle is dark blue with a red border and contains the text 'Radiotherapy'. The right circle is blue with a yellow border and contains the text 'Brachytherapy'. The circles overlap in pairs and in the center.

**External beam  
irradiation**

**Radiotherapy**

**Brachytherapy**



# Definition of target

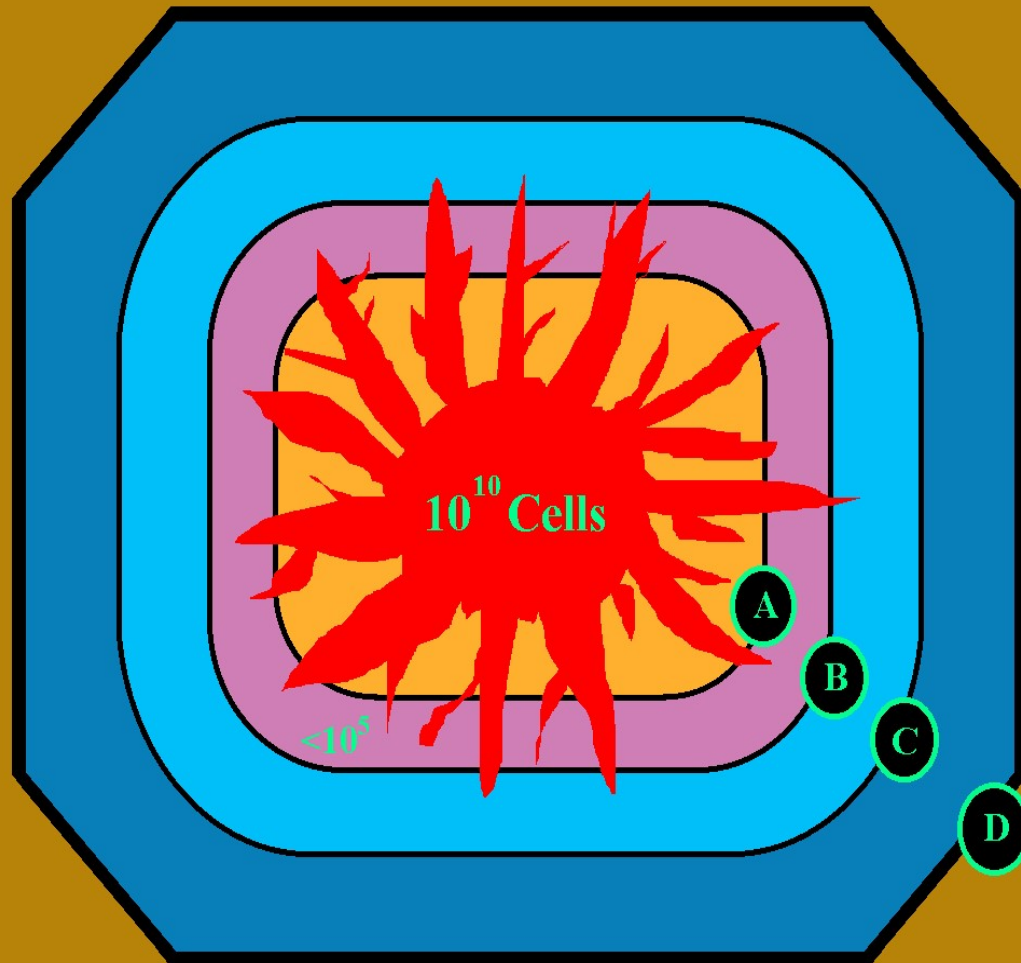

A - gross

B - clinical

C - planning

D - treatment

# TELETHERAPY

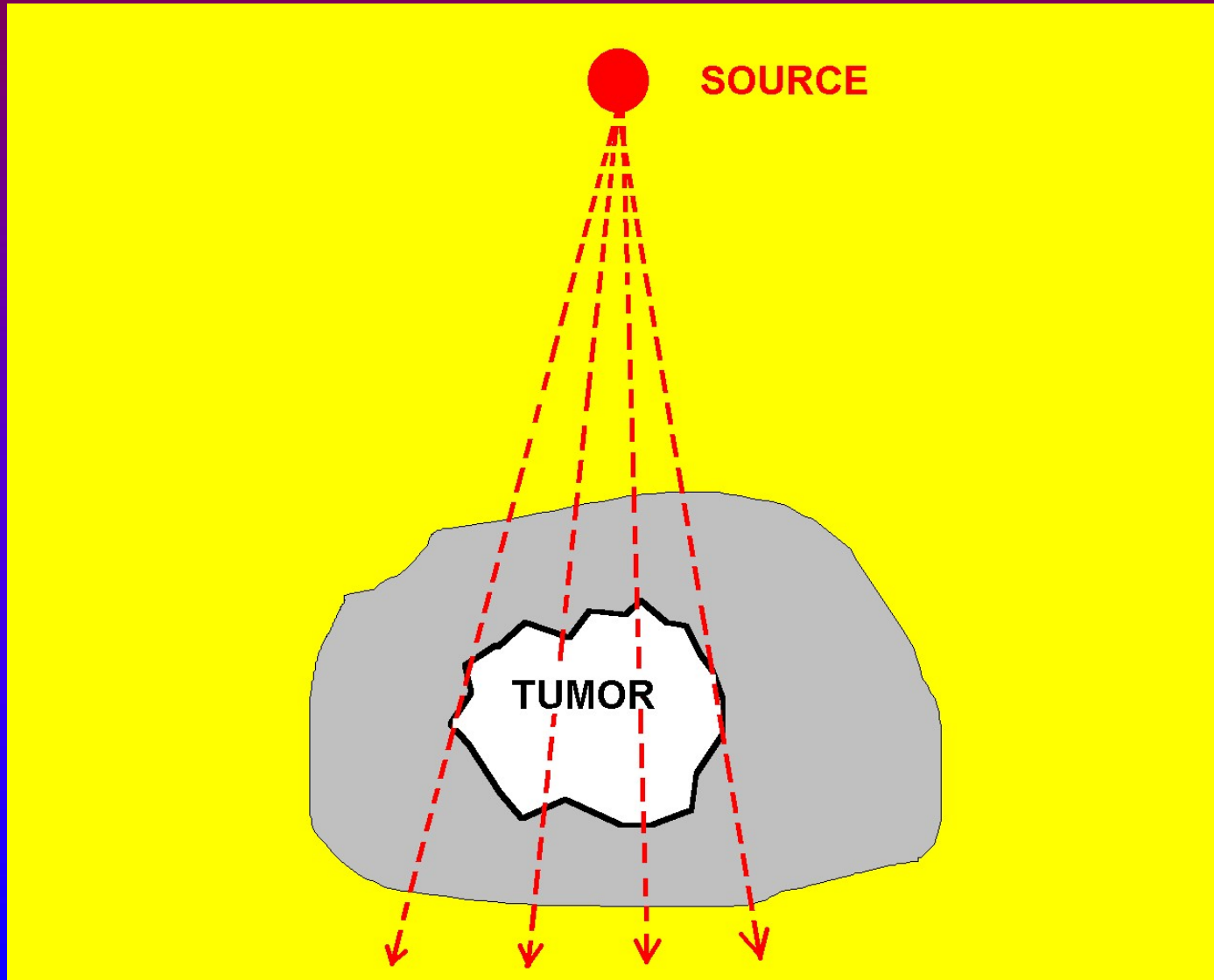

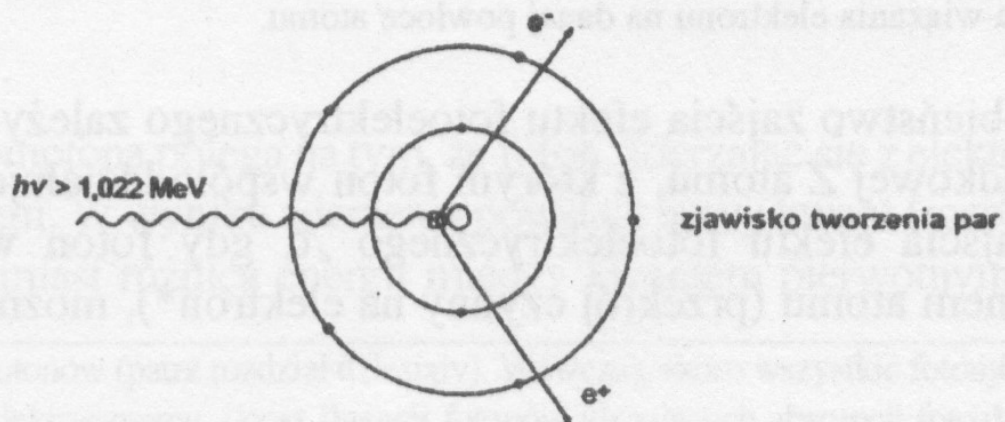
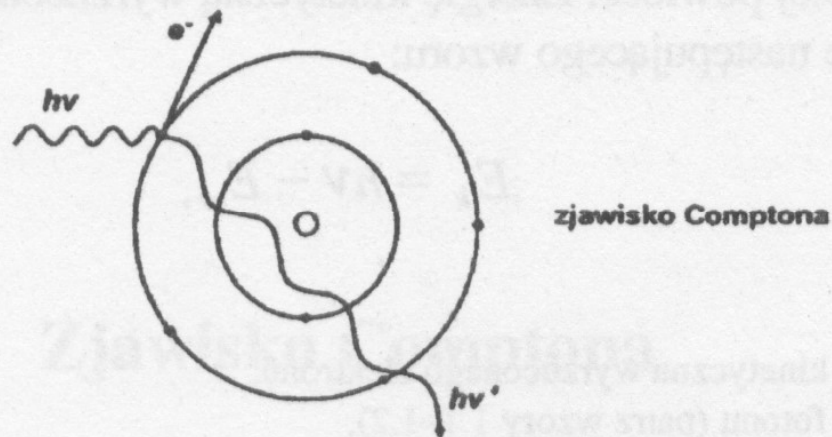
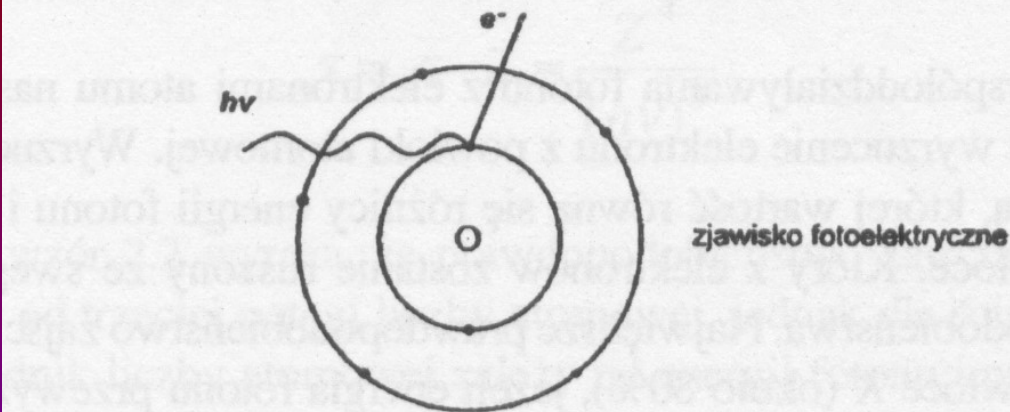

Ilustracja  
współoddziaływania  
promieniowania X lub  $\gamma$   
z atomem Zjawisko  
fotoelektryczne z  
wewnętrznymi  
elektronami atomu,  
zjawisko Comptona z  
zewnątrznymi  
elektronami powłoki  
atomu, zjawisko  
tworzenia par w polu  
elektrycznym jądra  
atomowego.

# Szkic rozproszenia fotonu w zjawisku Comptona

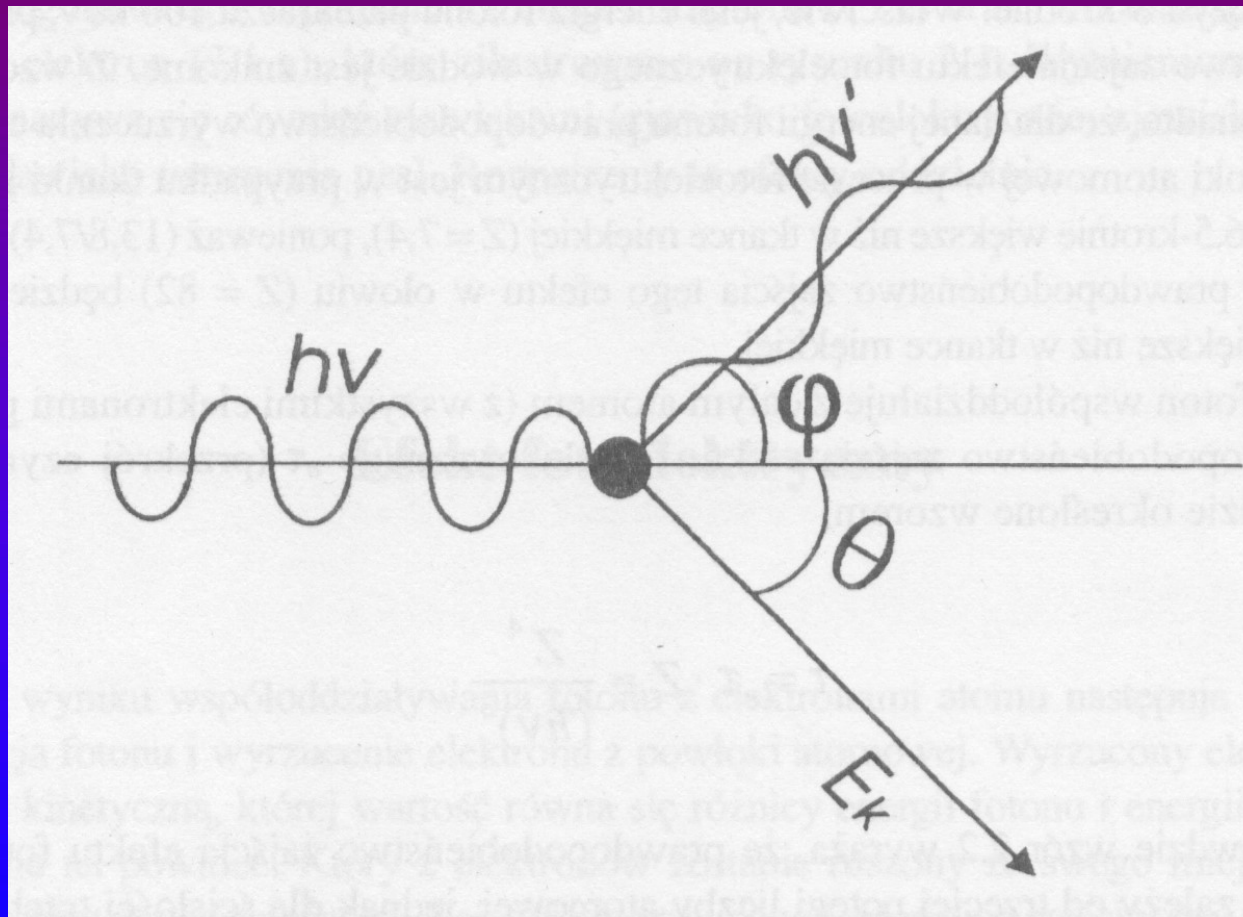

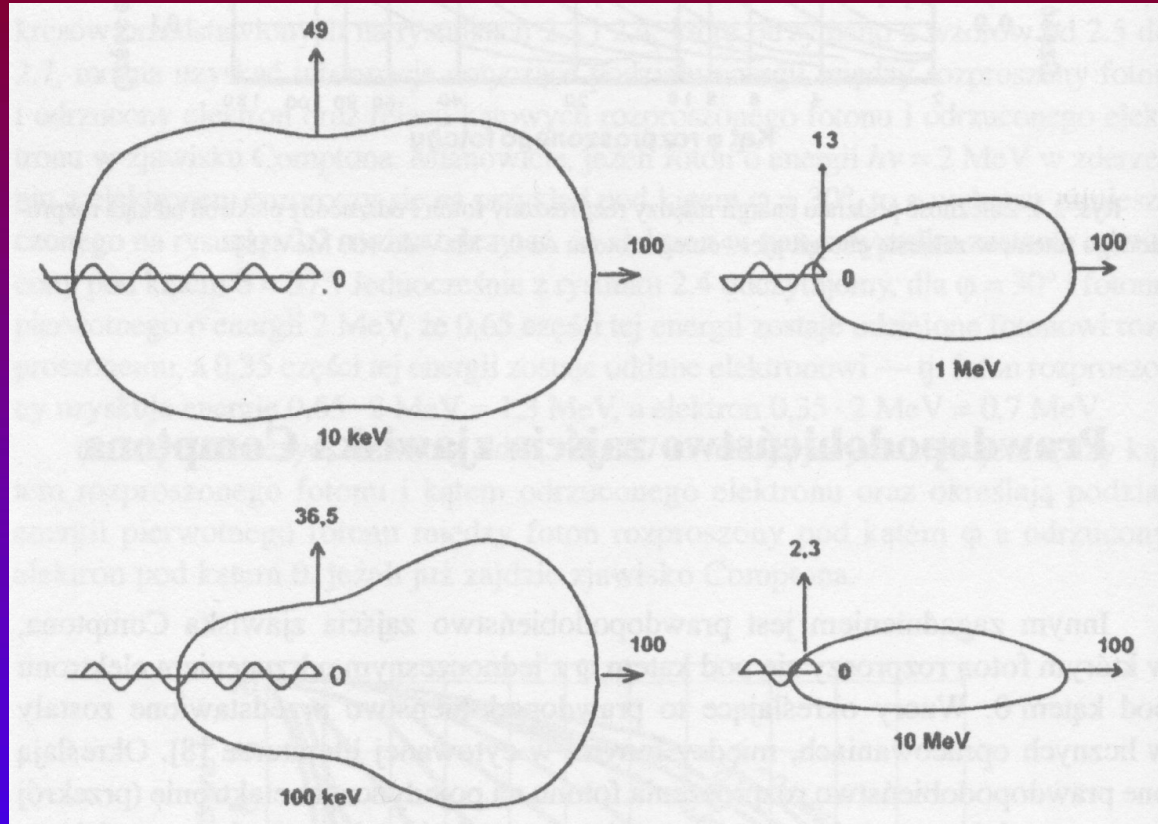

**Kątowy rozkład promieniowania rozproszonego w biegunowym układzie współrzędnych w zależności od energii oddziałującego fotonu .Długość promienia wyprowadzonego z punktu 0 w wybranym kierunku określa względne prawdopodobieństwo rozproszenia fotonu w tym kierunku w stosunku do prawdopodobieństwa rozproszenia w kierunku ruchu fotonu pierwotnego.**

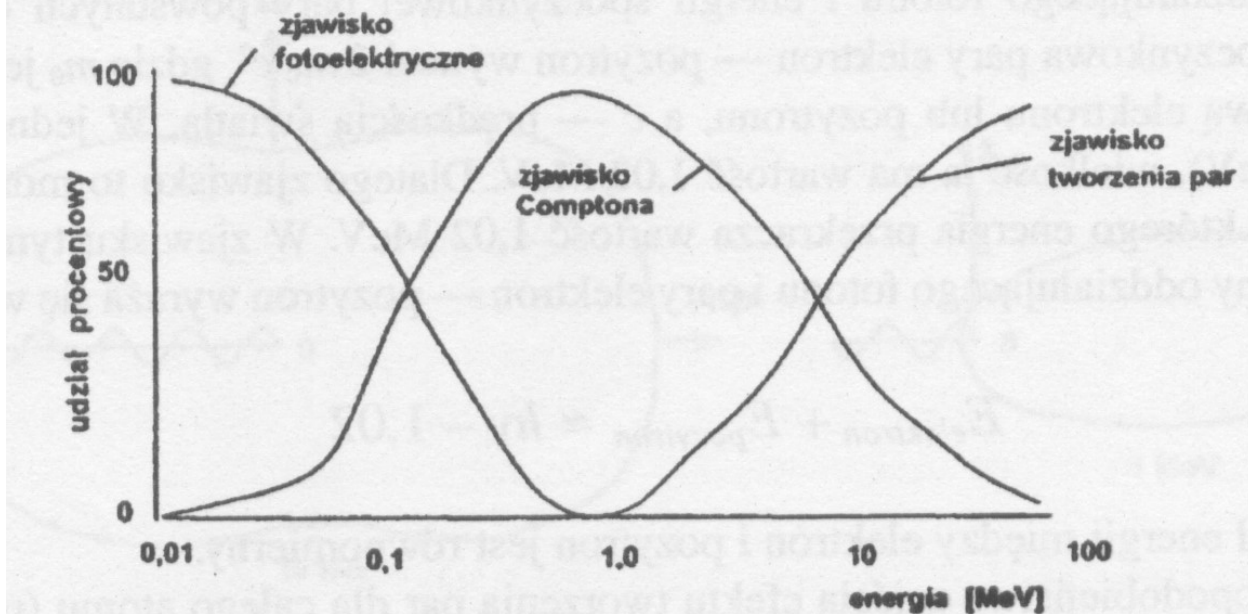
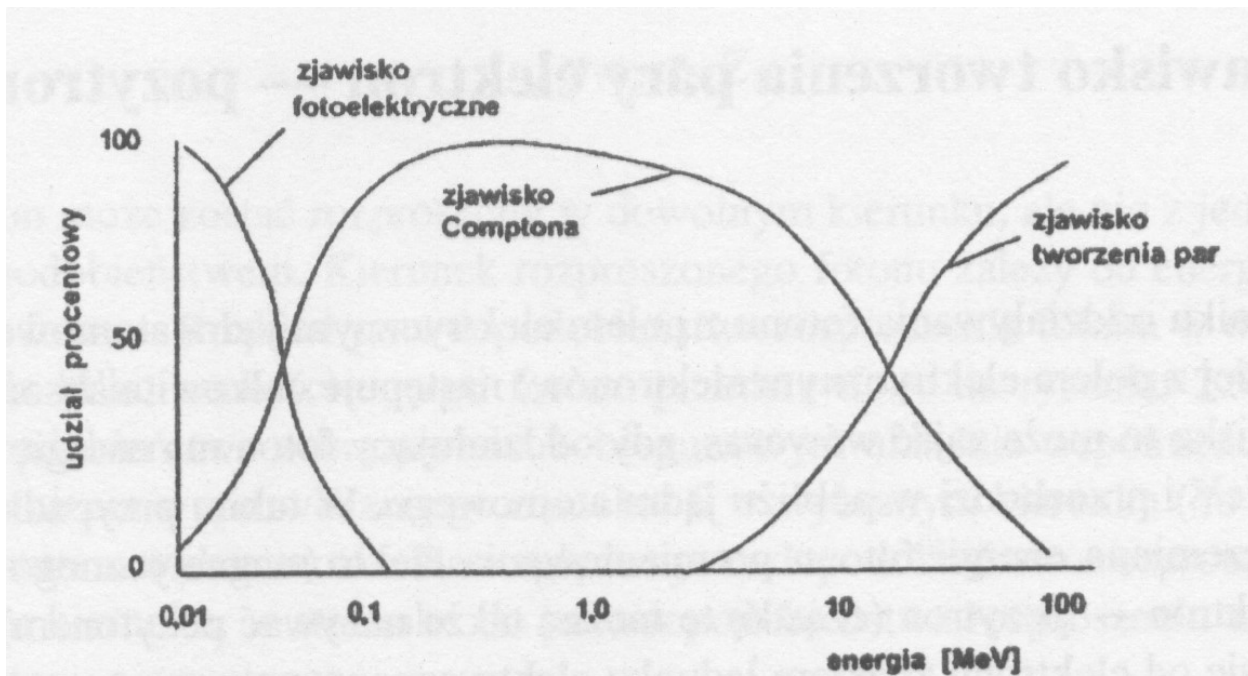

Procentowy udział poszczególnych zjawisk oddziaływania fotonów w zależności od energii fotonów: dla wody (na górze) i dla miedzi (na dole).

Przykładowy rozkład izodoz dla pojedynczej wiązki promieniowania fotonowego.

Najczęściej wartości izodoz podaje się co 10%: a — dla promieniowania rentgenowskiego; b — dla promieniowania  $\gamma^{60}\text{Co}$ ; c — dla promieniowania X generowanego w liniowym przyspieszaczach elektronów.

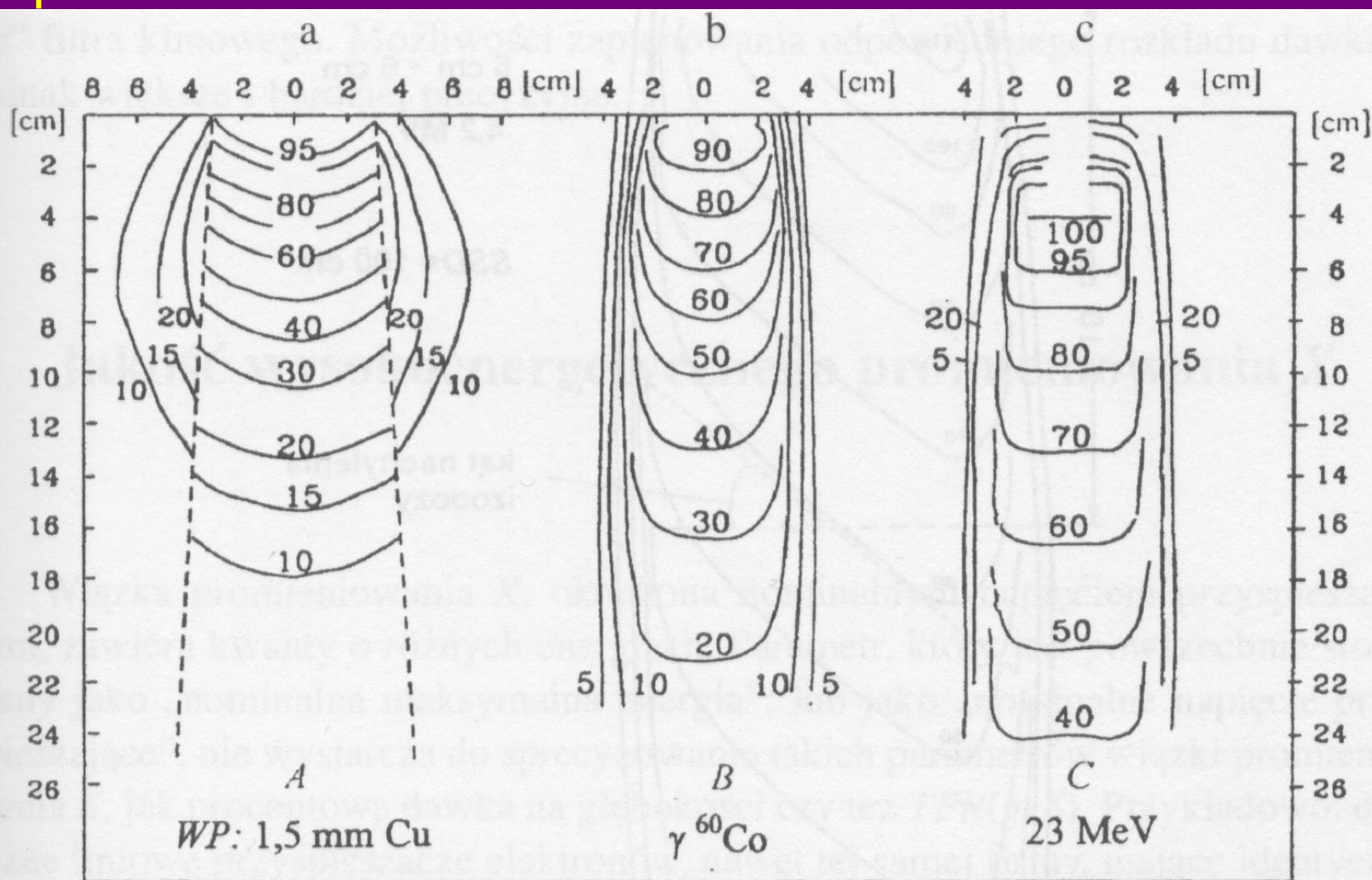

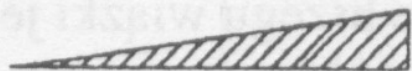

filtr klinowy

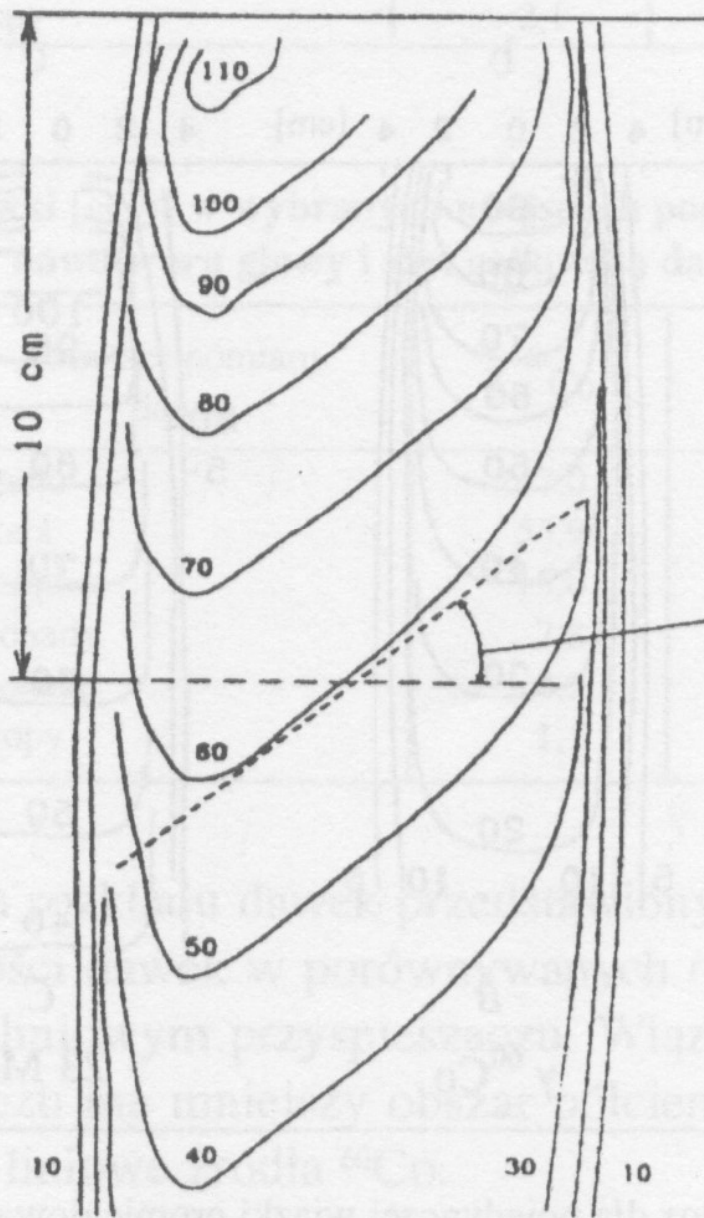

6 cm • 6 cm

4,2 MV

SSD= 100 cm

kąt nachylenia  
izodozy

Przykładowy rozkład izodoz z użyciem filtra klinowego. Kąt nachylenia izodozy na głębokości 10 cm określa nazwę klina.



# PERCENTAGE DEPTH DOSE

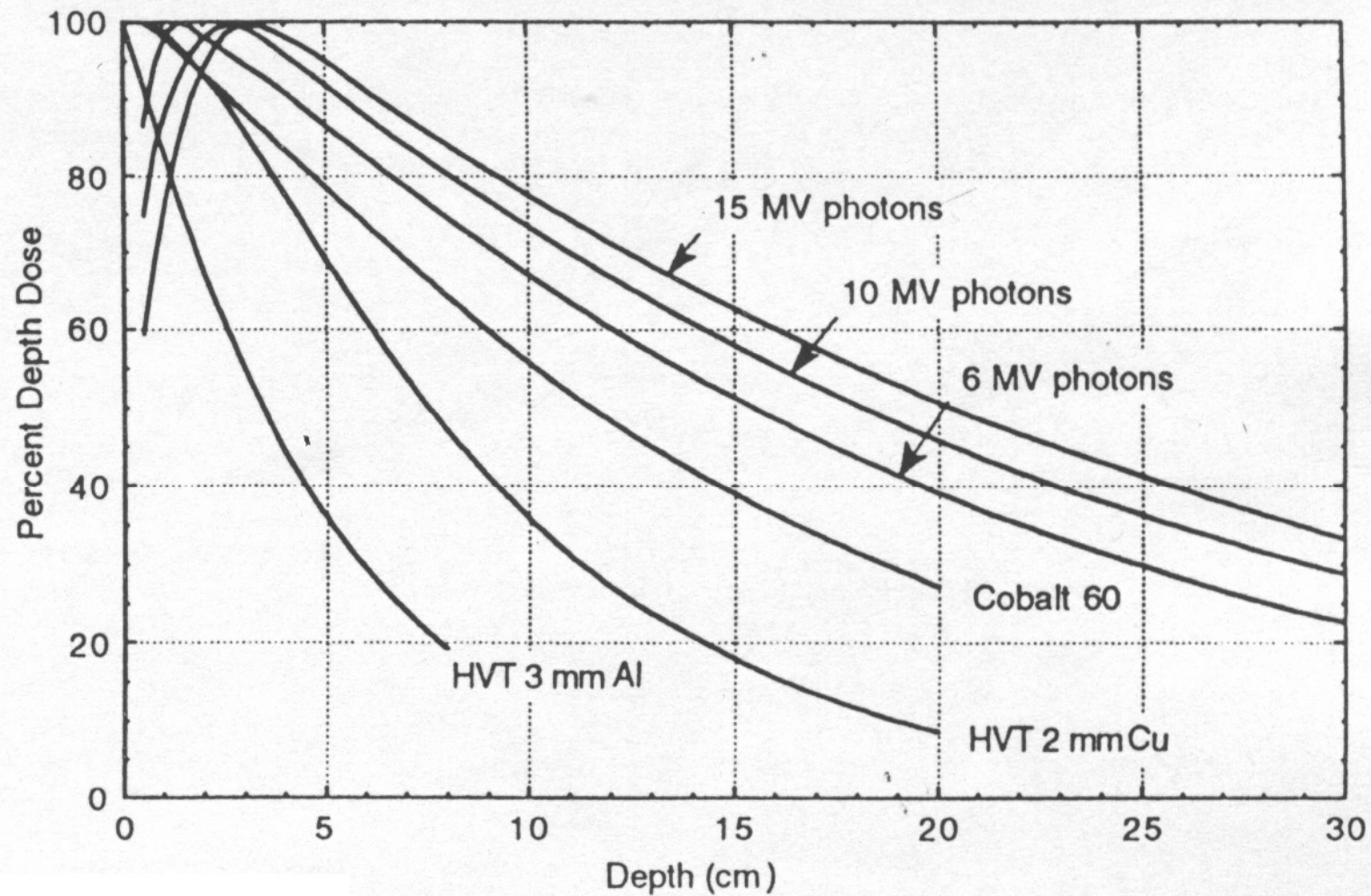

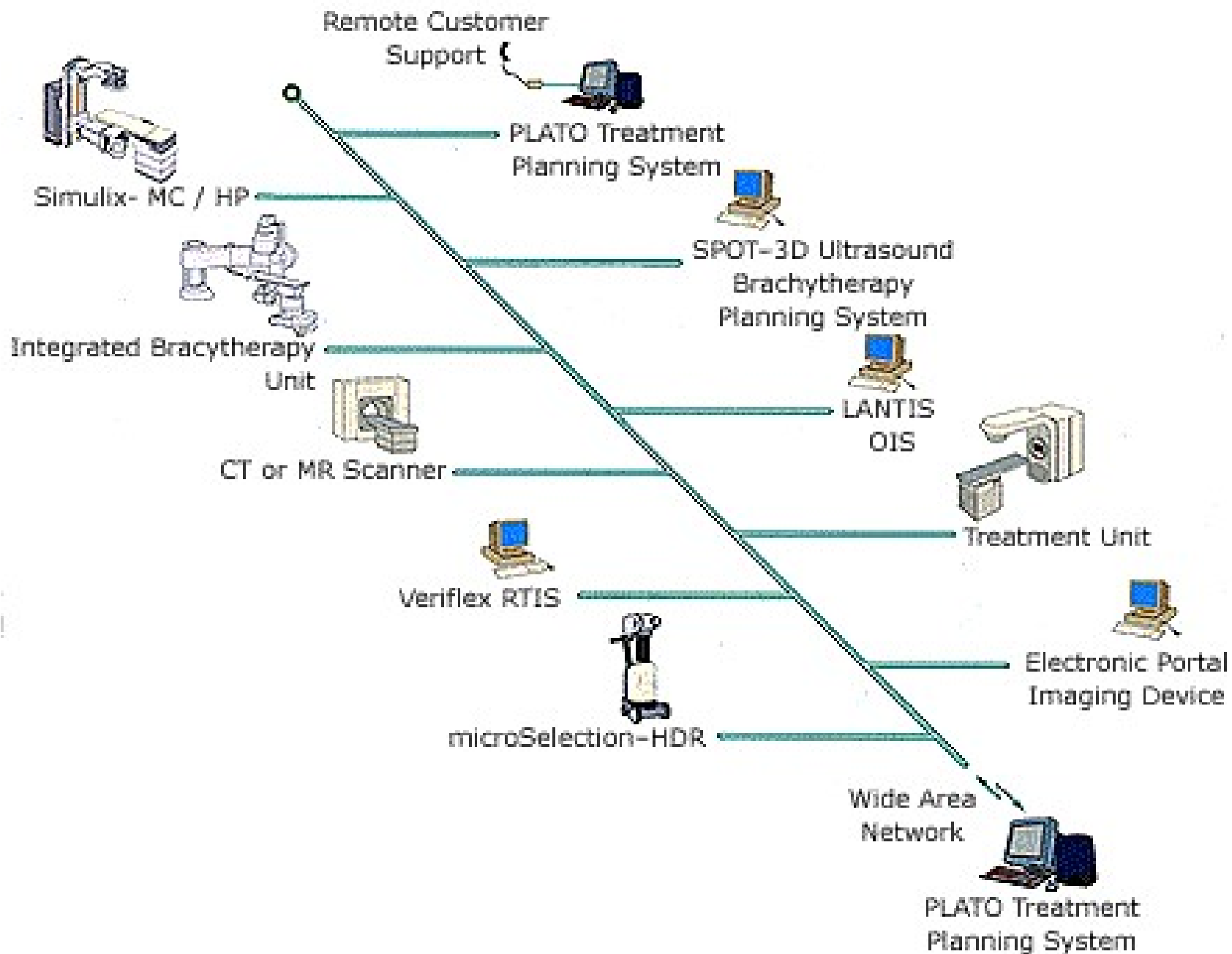

# IRRADIATED AREA

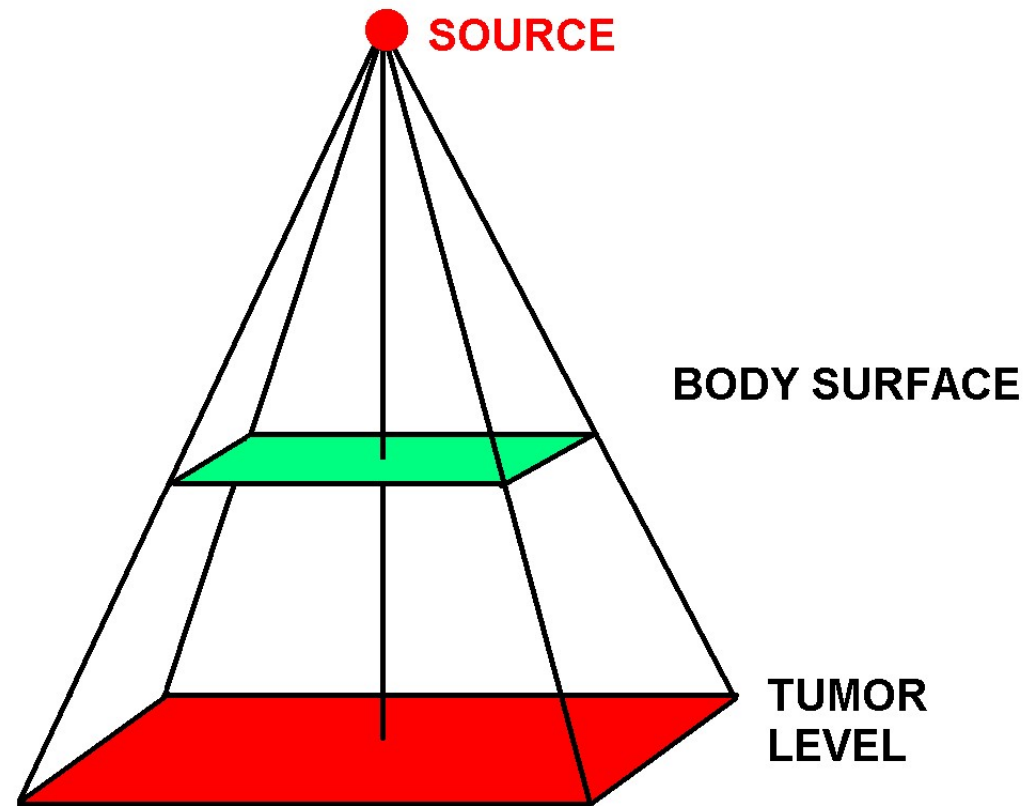

# ISODOSE CURVES

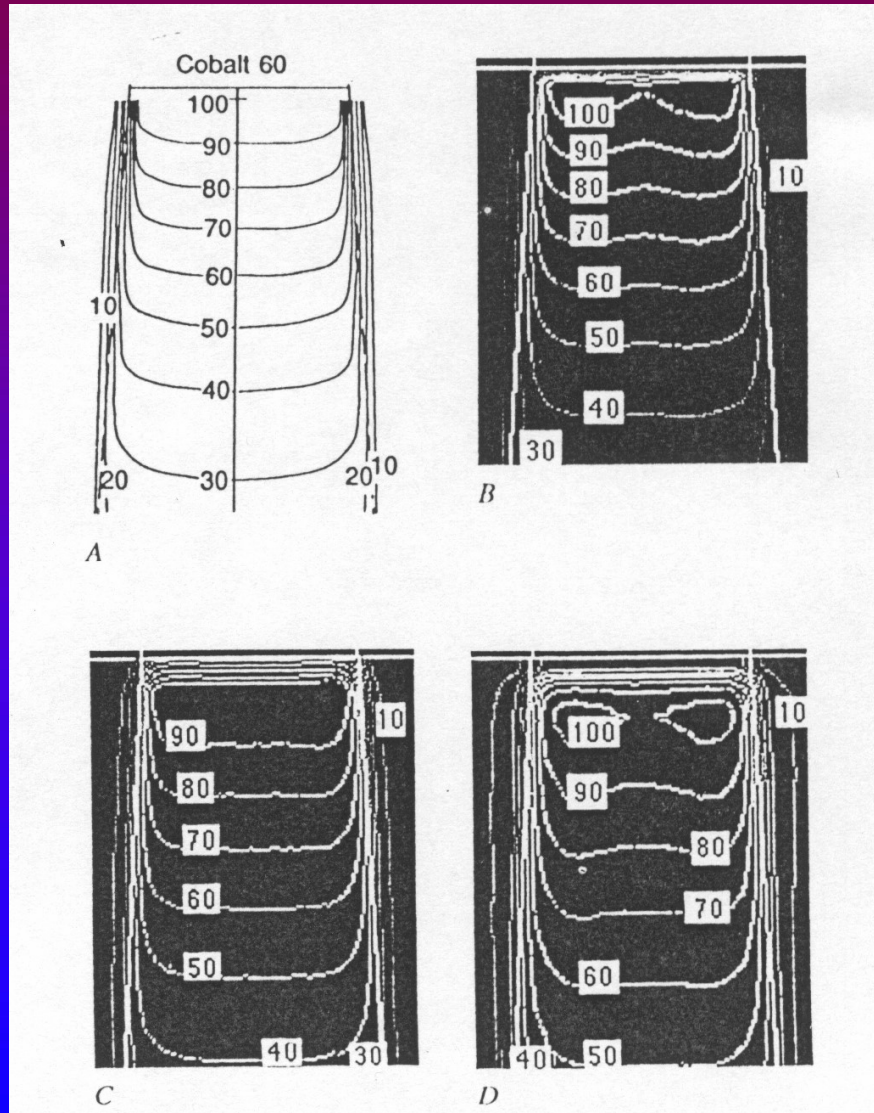

**A - Co - 60**

**B - 4 MV photon  
beam**

**C - 6 MV photon  
beam**

**D - 15 MV  
photon beam**

# BEAM ROTATION

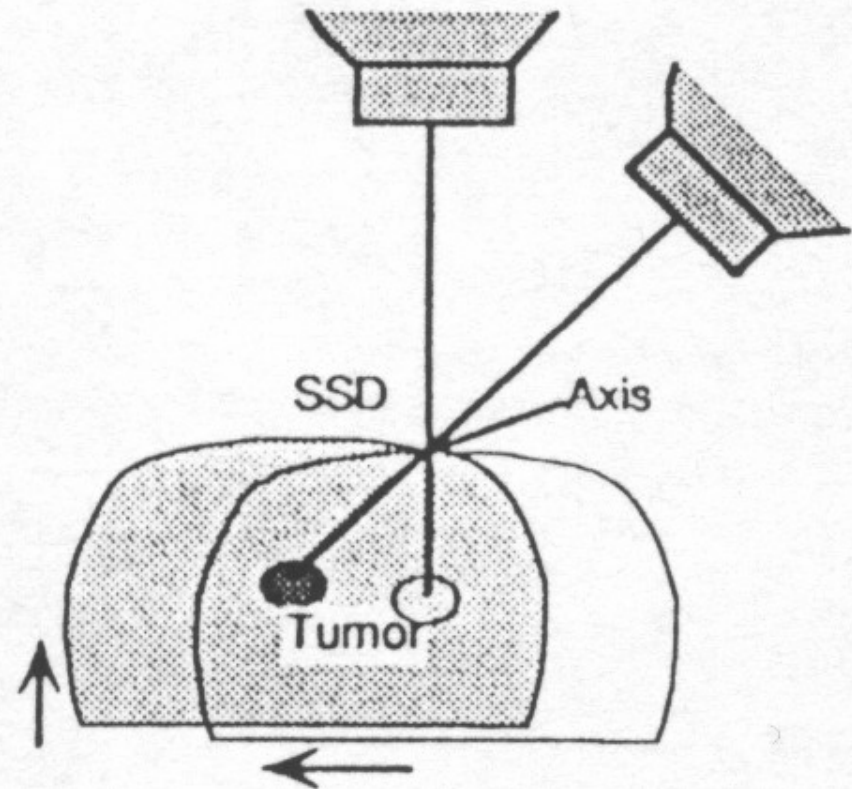
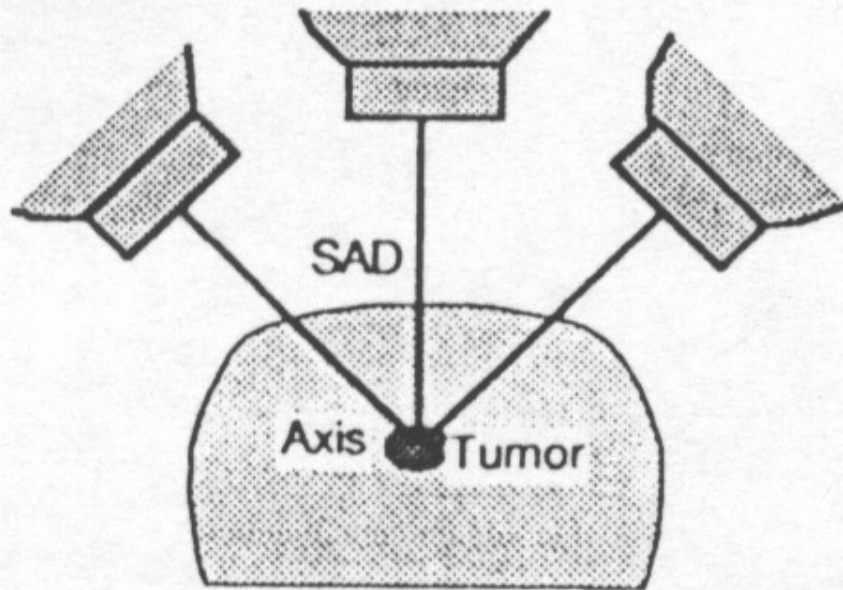

**SOURCE AXIS DISTANCE**

**SOURCE SKIN DISTANCE**

# PENUMBRA, COLIMATION

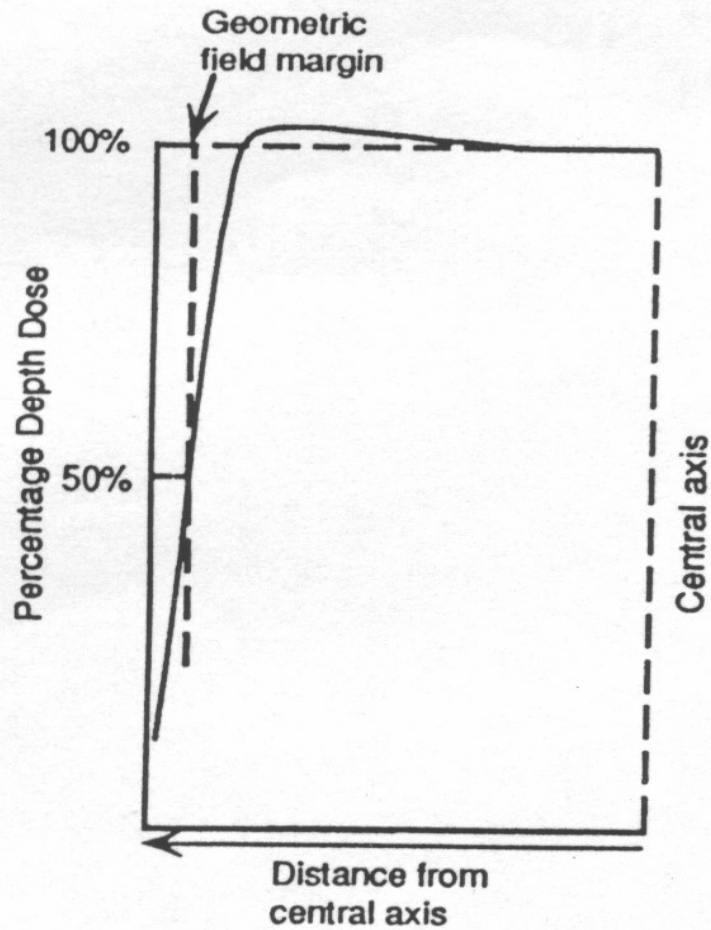

A

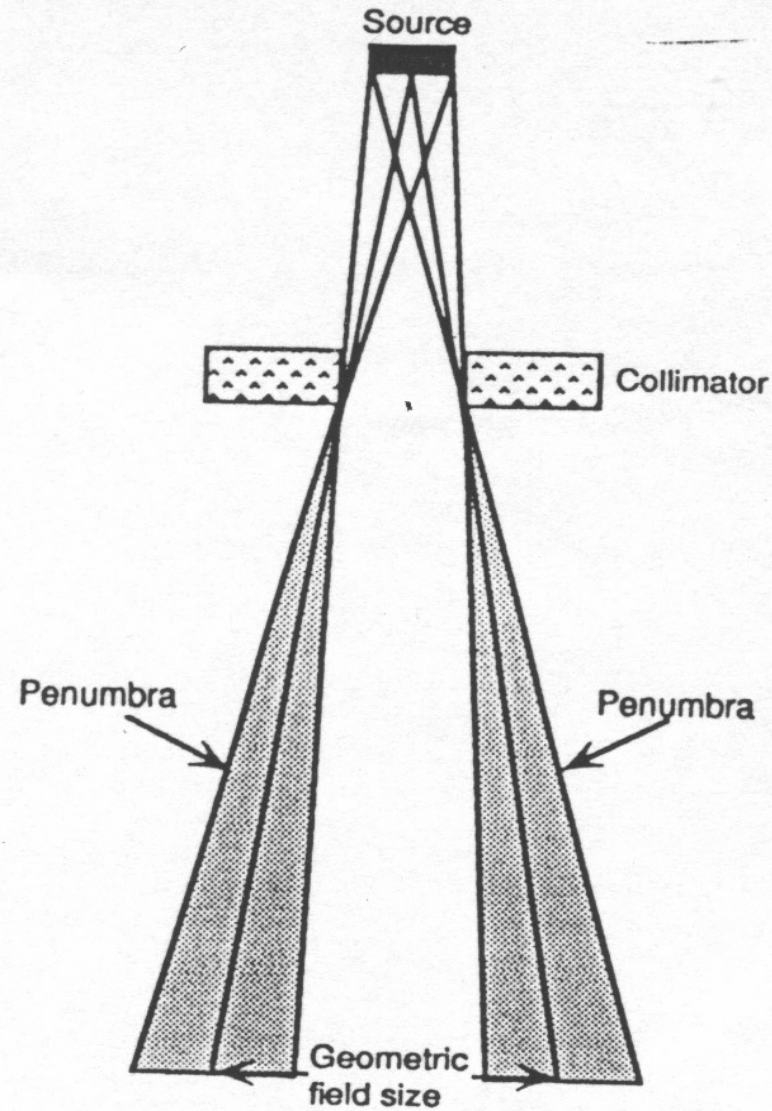

B

# BEAM'S EYE VIEW

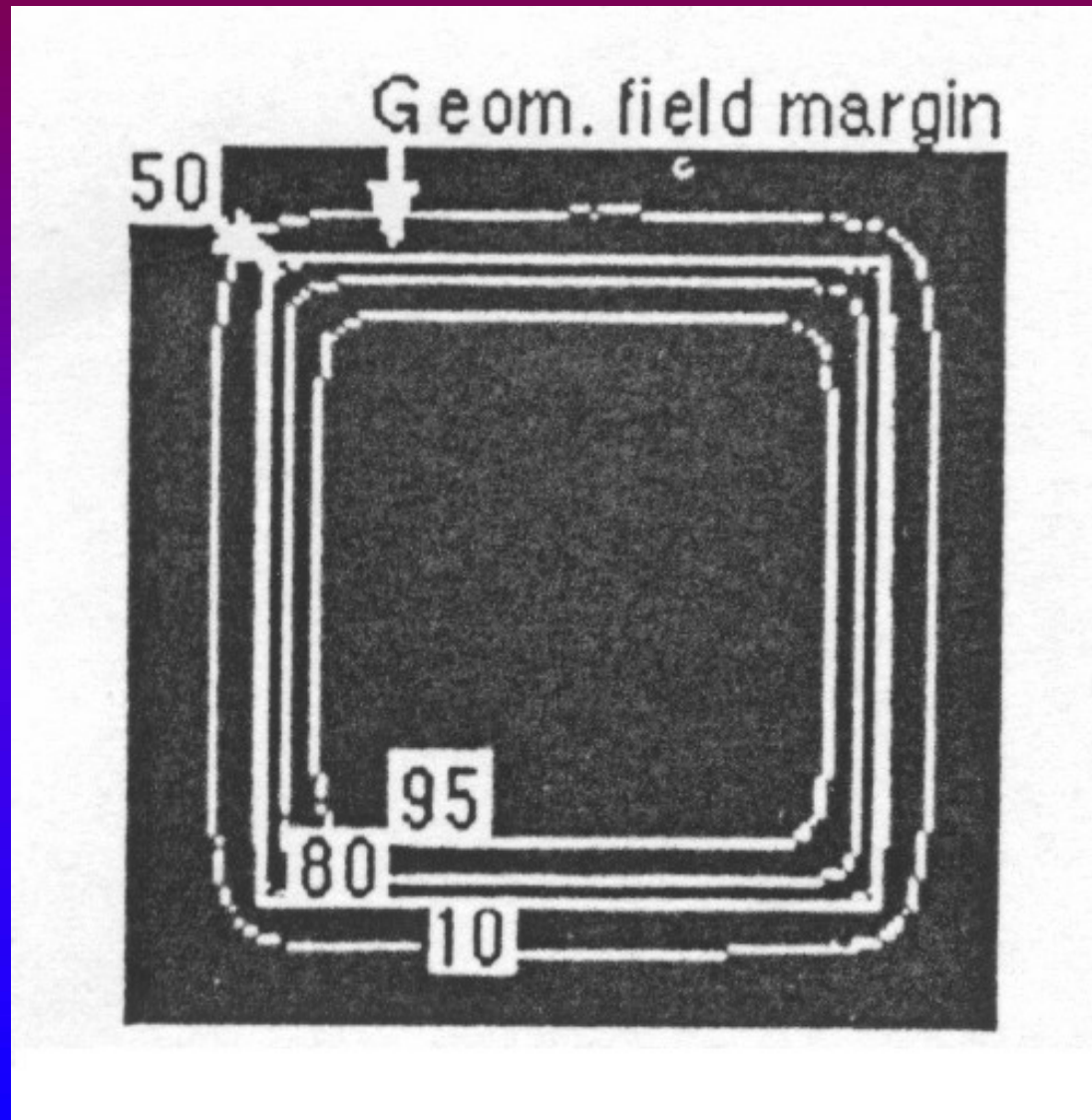

# WEDGES

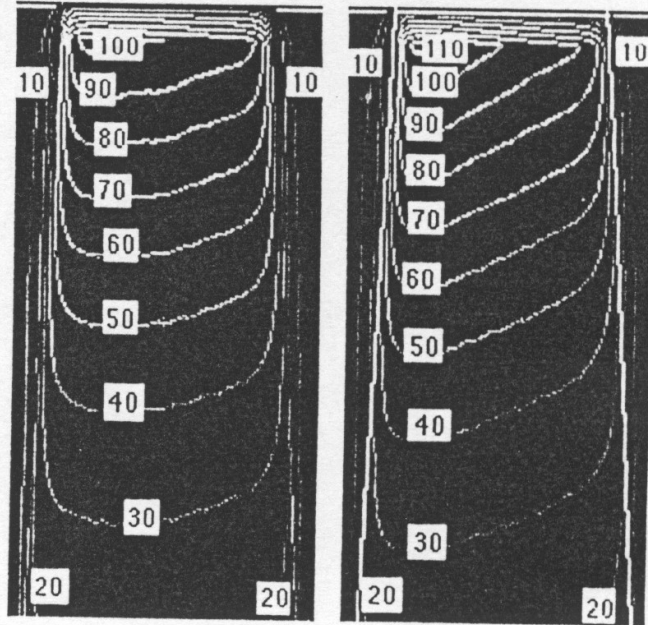

A

B

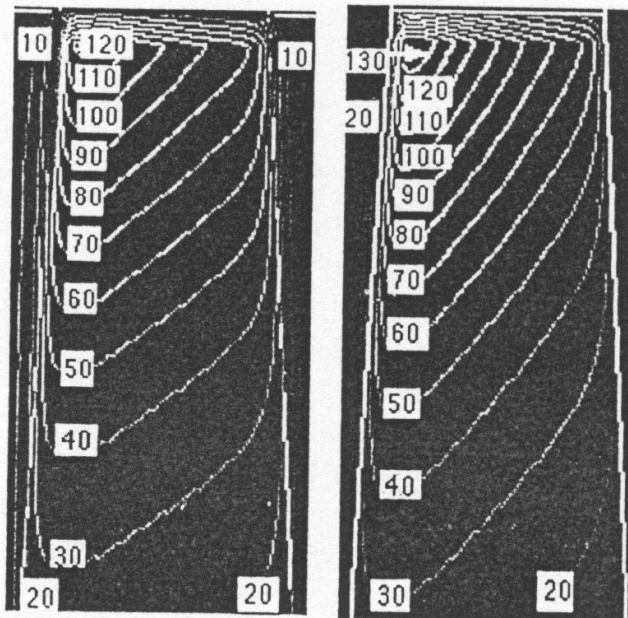

C

D

A - 15°

B - 30°

C - 45°

D - 60°





# Virtual Simulation

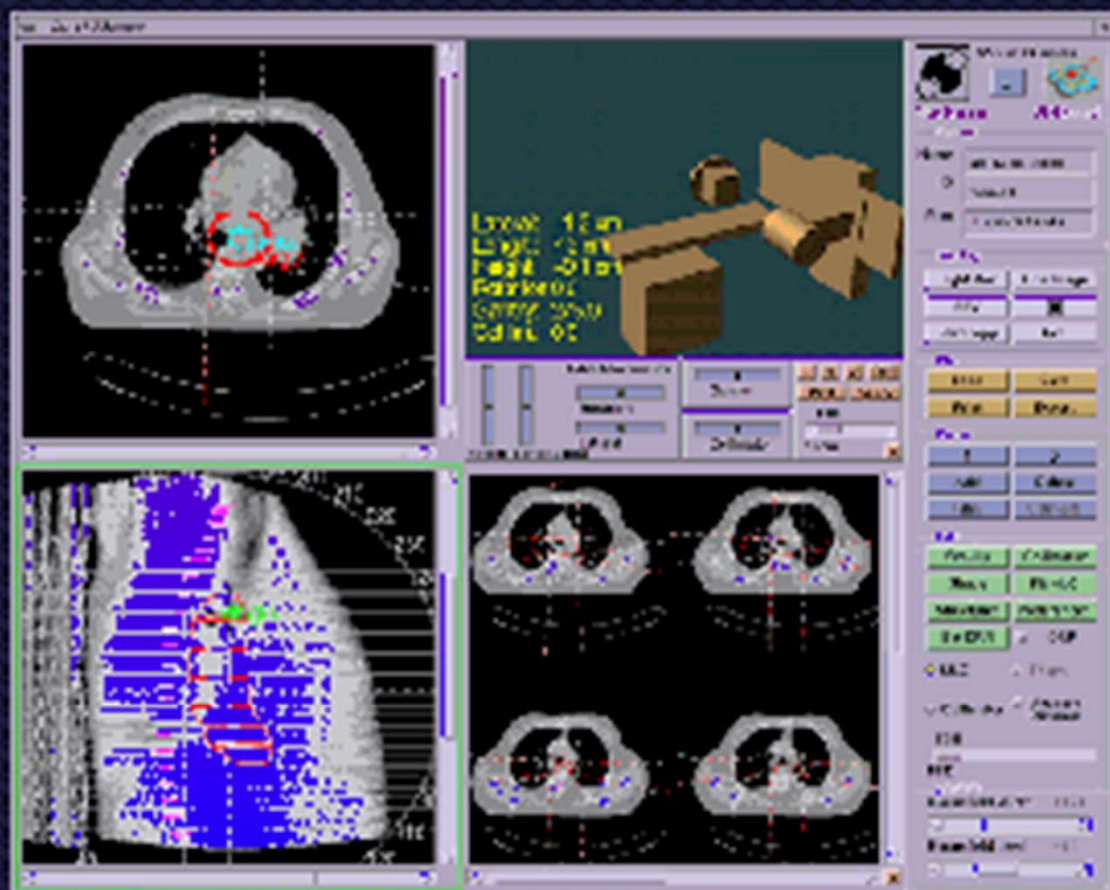

Clear representation  
of machine position  
and field coverage

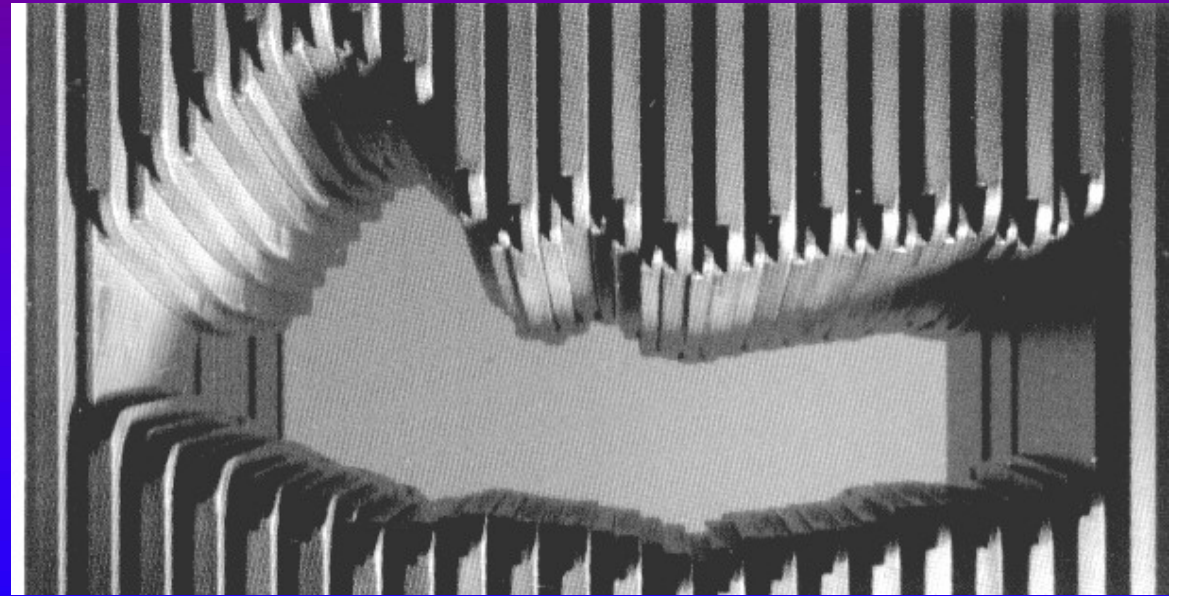

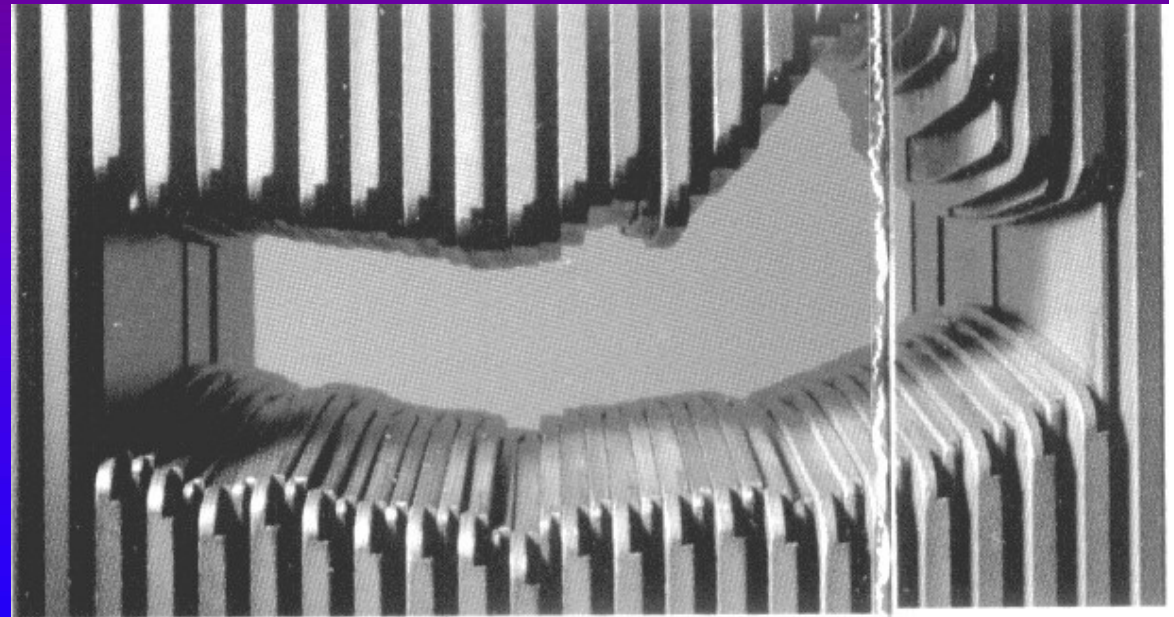

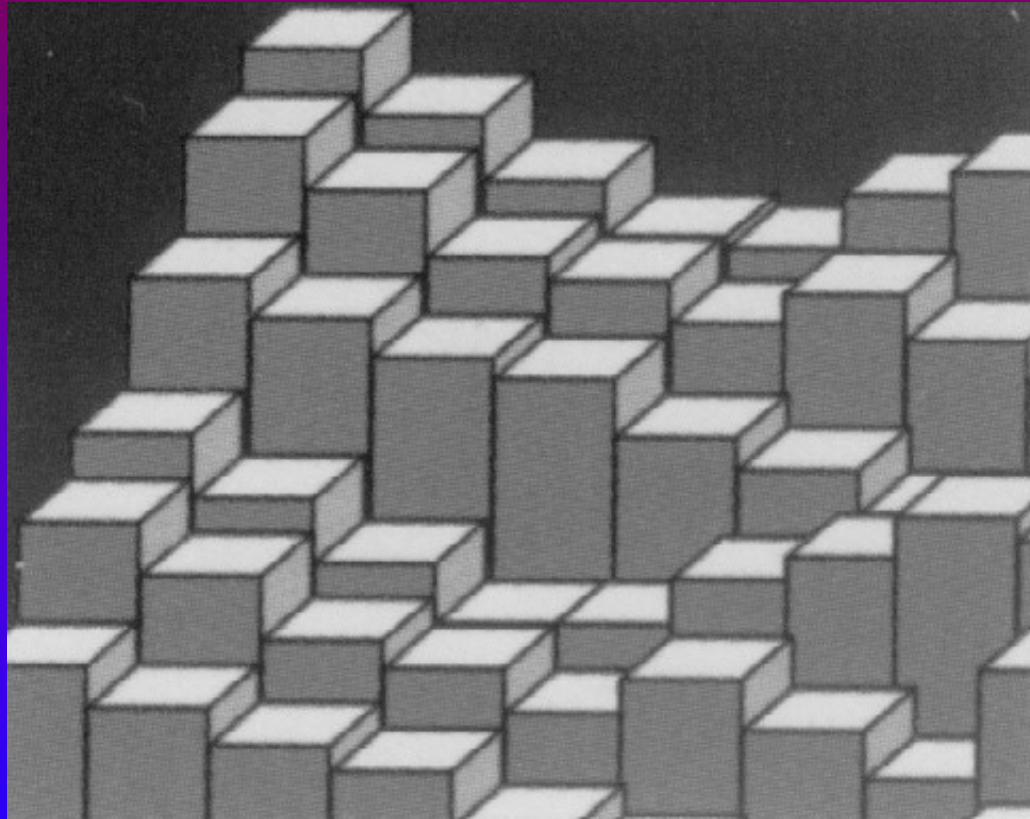

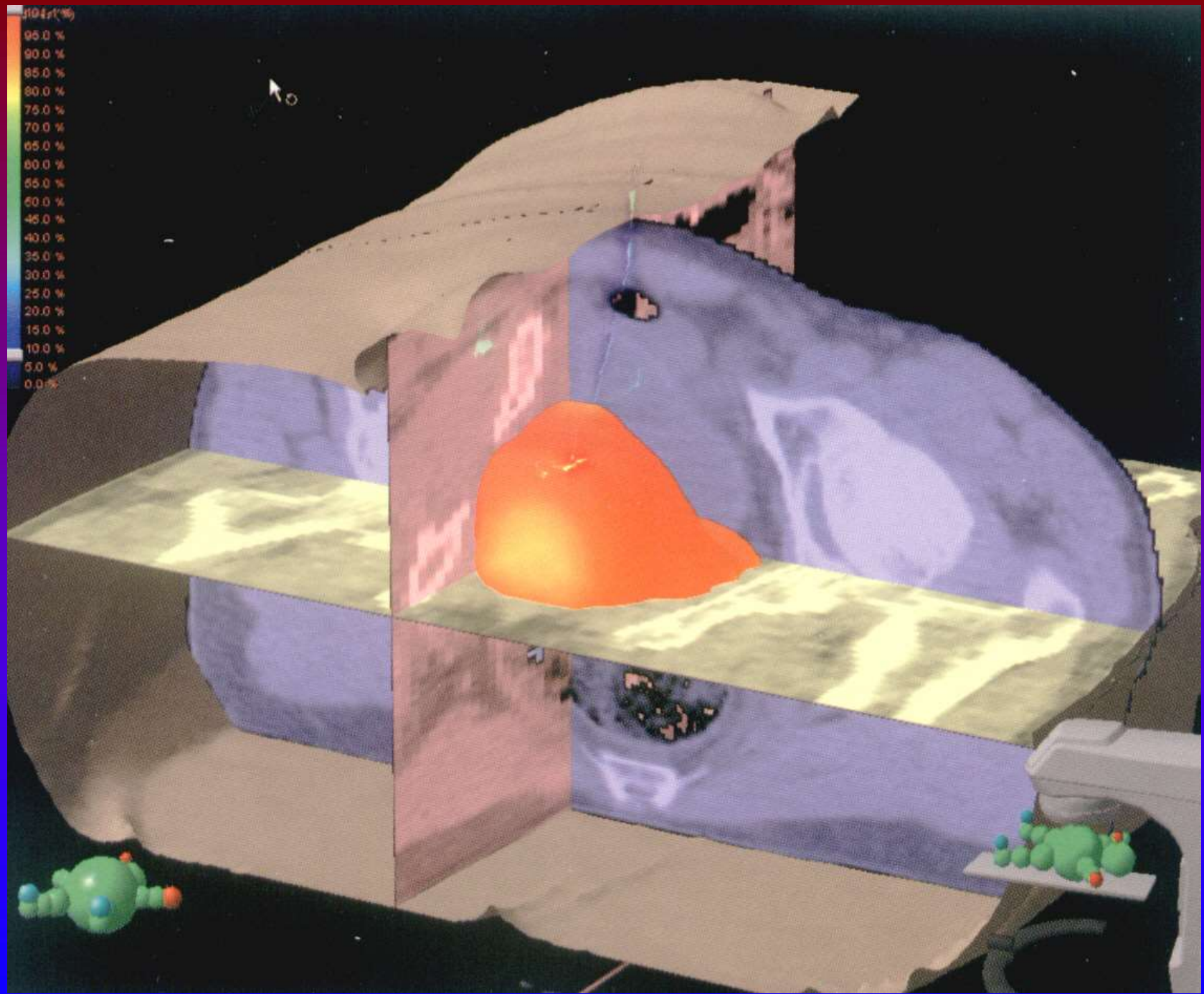

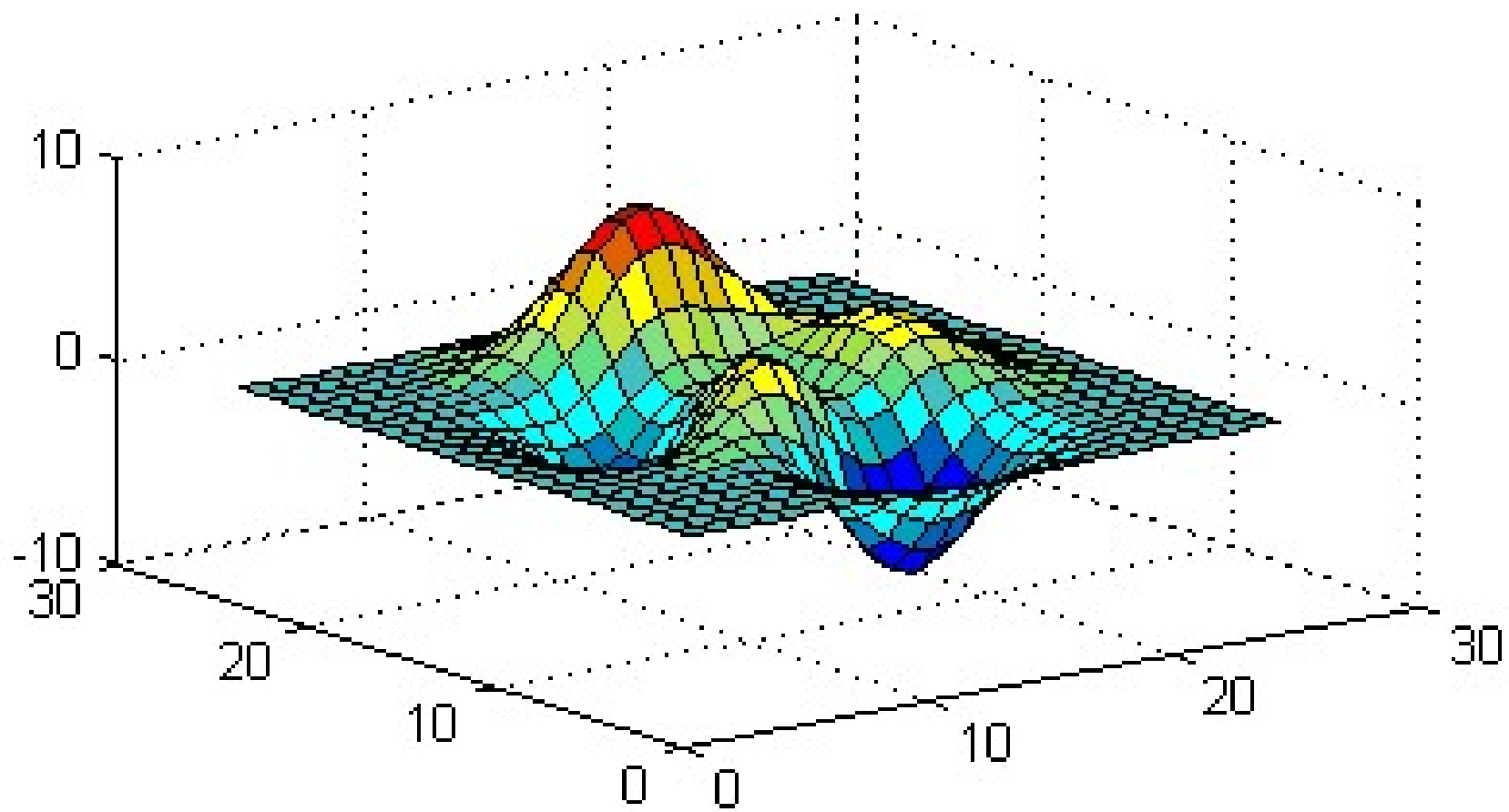





# Malignancies required irradiation

- ***RADIOSENSITIVITY*** expresses the response - degree and speed of regression- of the tumor to irradiation.
- ***RADIOCURABILITY*** refers to the eradication of tumor and reflects a direct effect of the irradiation, which may not parallel the patient's ultimate outcome.

# Physical consideration

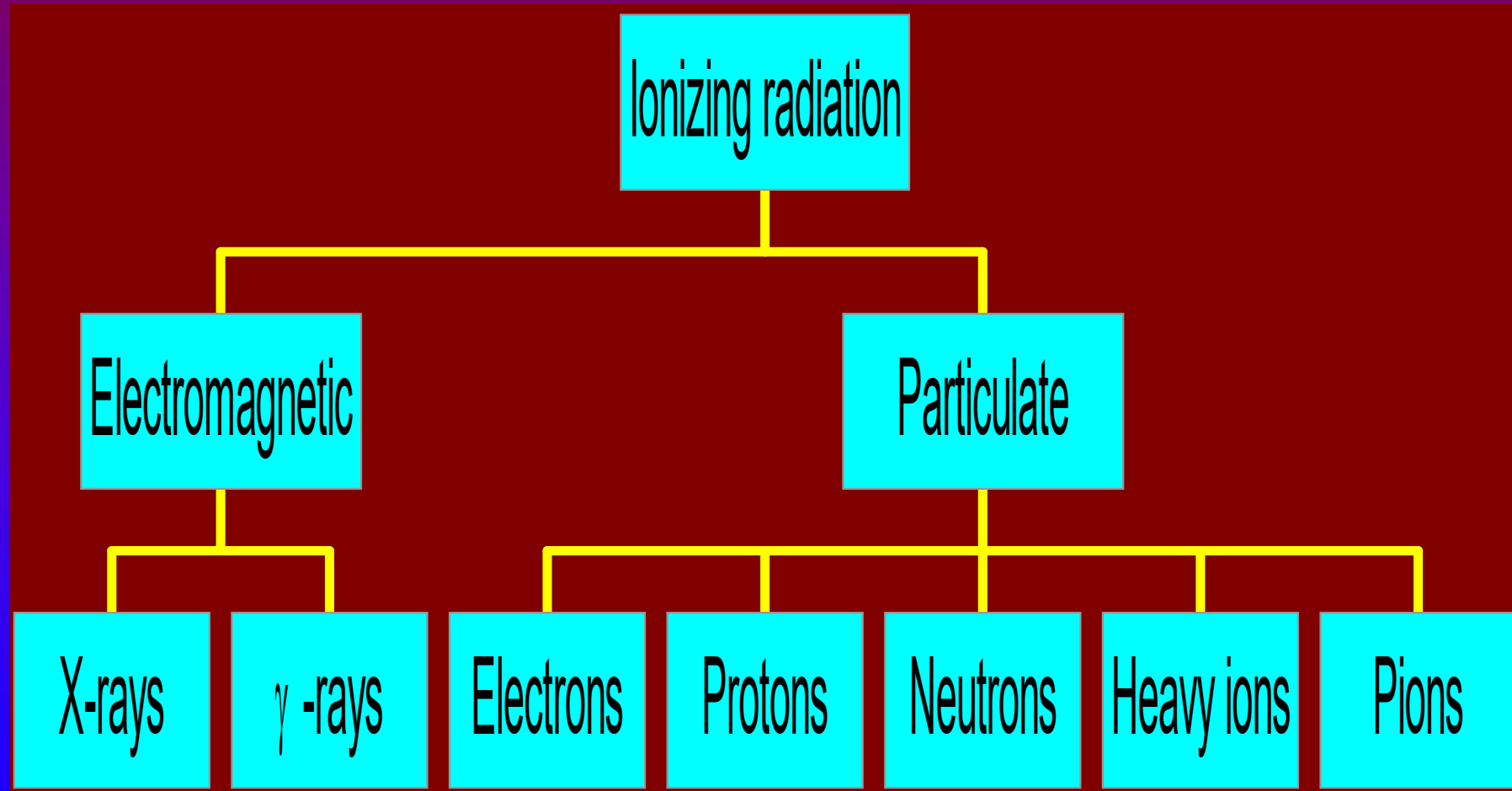

## Physical consideration (2)

- **LET** - linear energy transfer ( $D_e/dt$ )
- **RBE** - relative biologic effectiveness

# Radiobiology - essential information

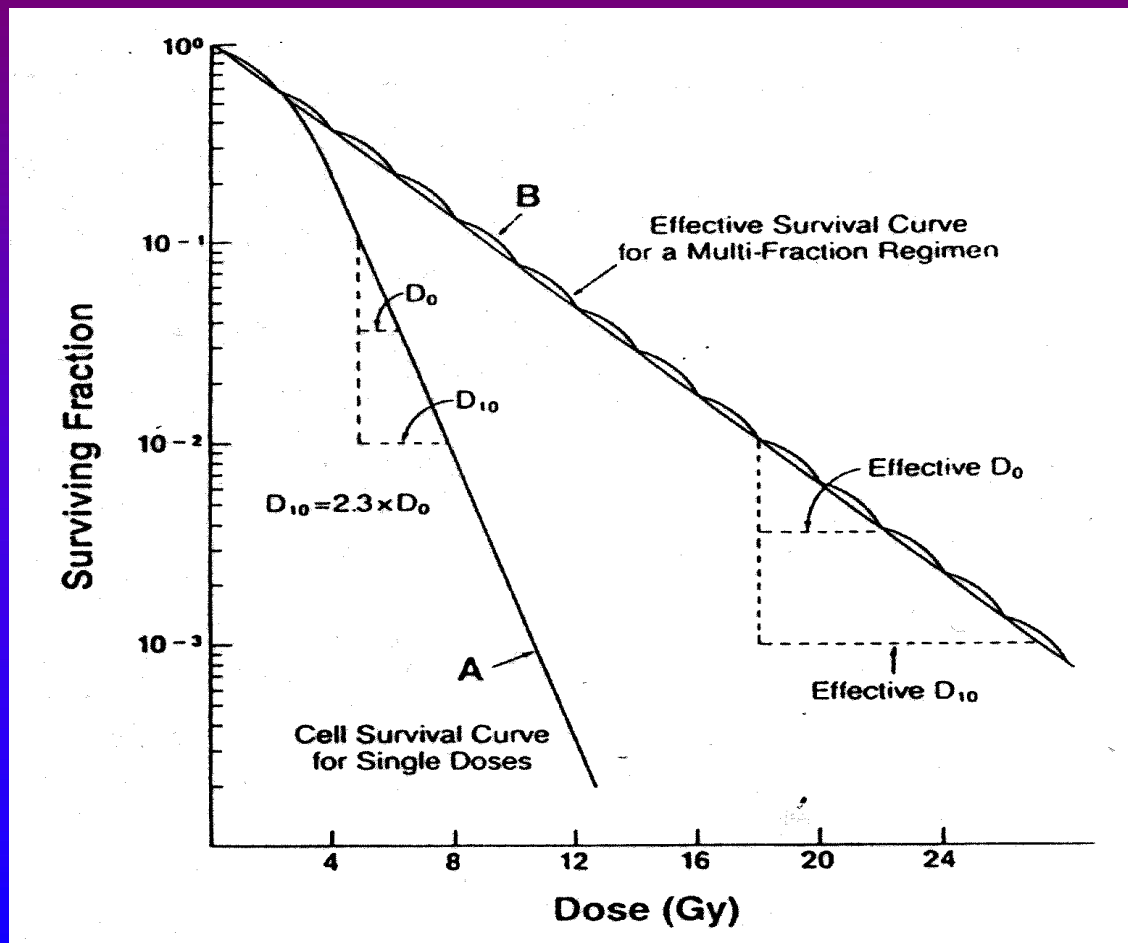

# Radiobiology - essential information

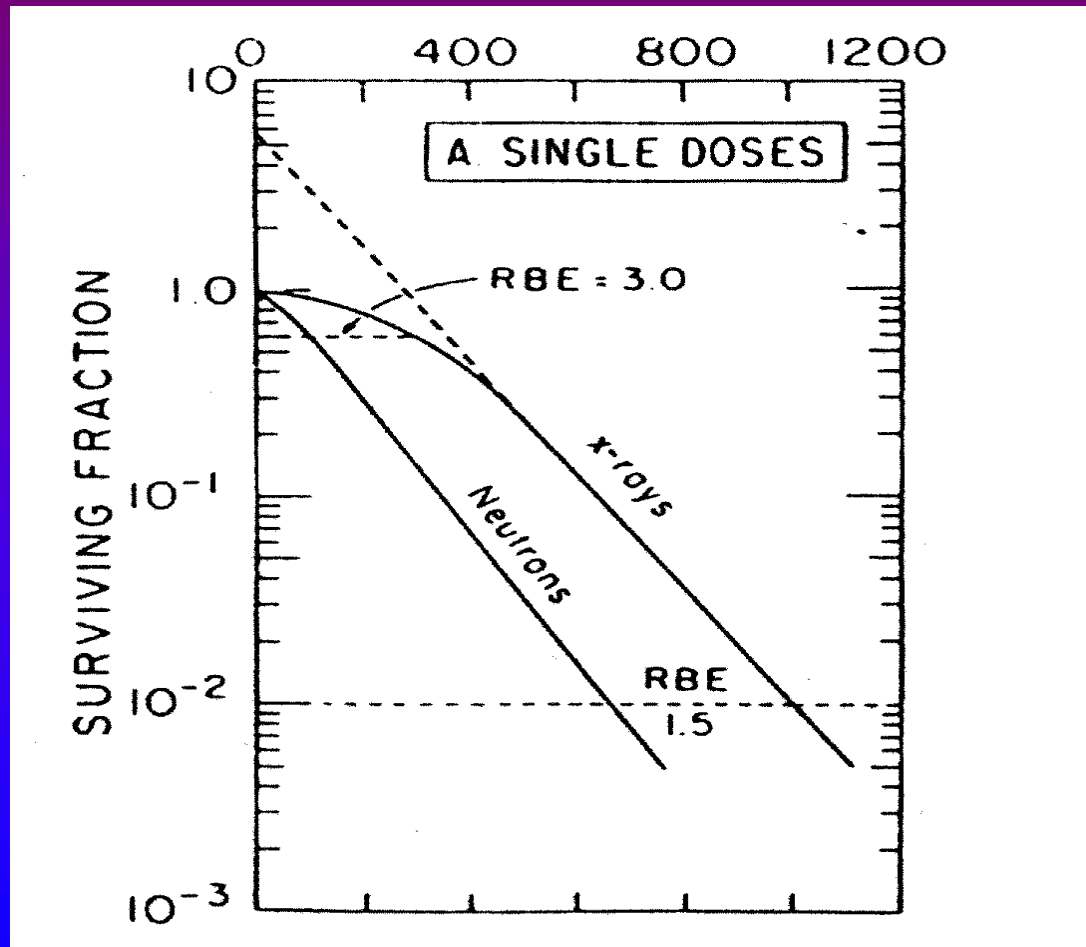

# Radiobiology - essential information

## 1. Repair

- potentially lethal damage repair
- sublethal damage repair

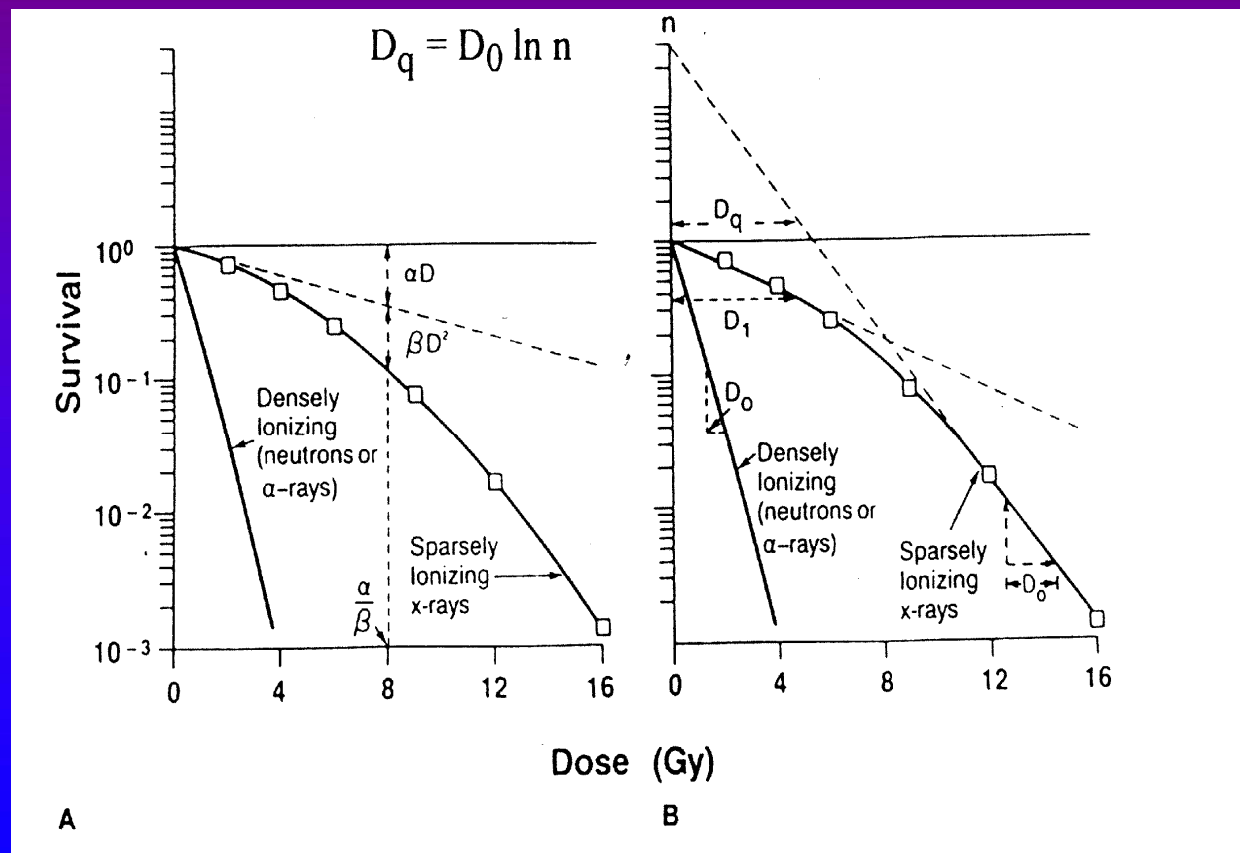

# Radiobiology - essential information

## 2. Repopulation

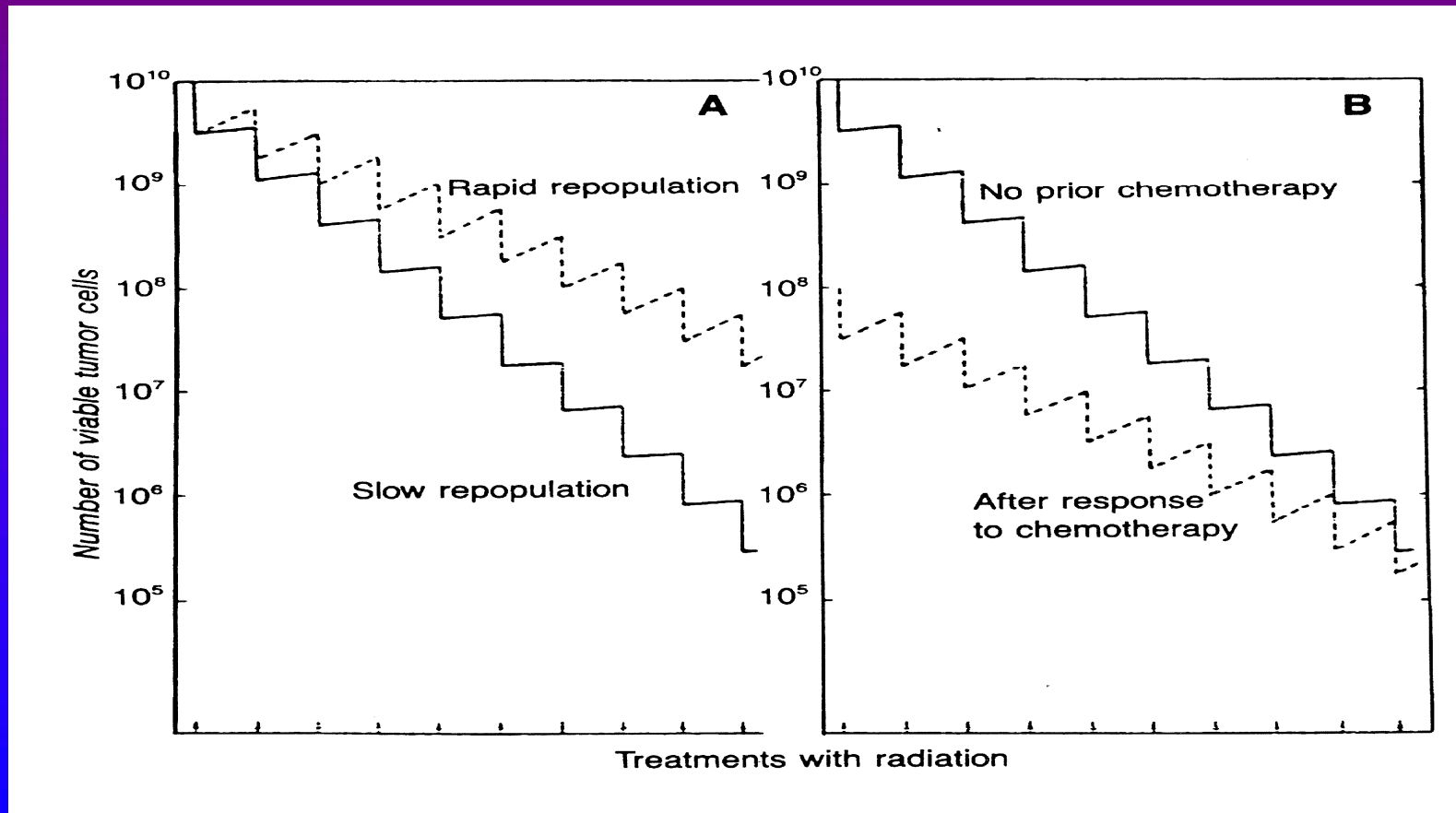

# Radiobiology - essential information

## 3. Reoxygenation

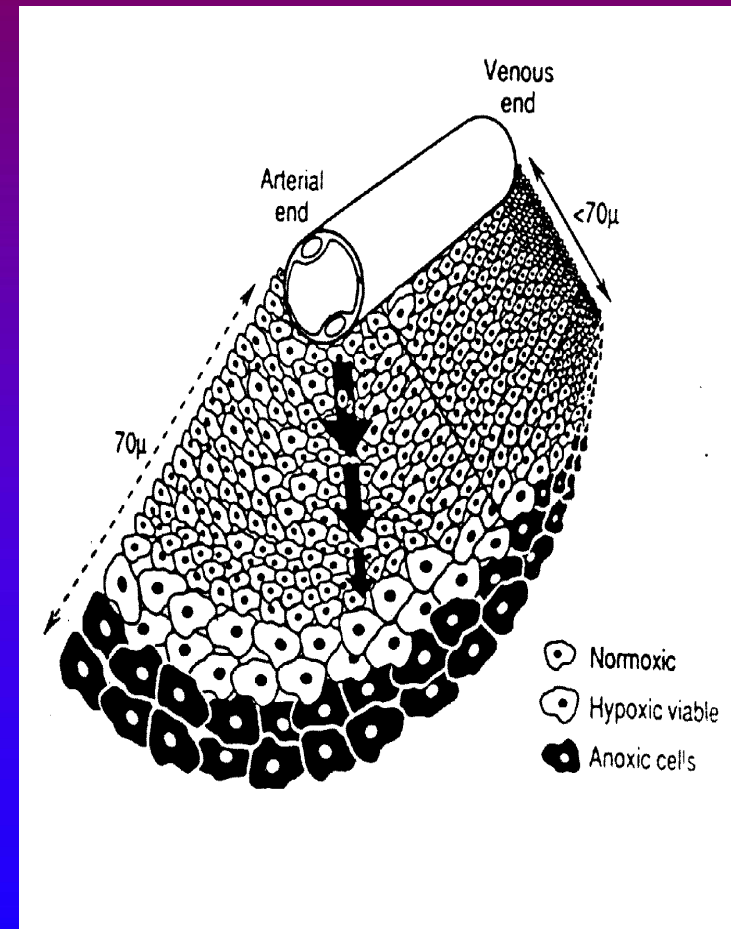
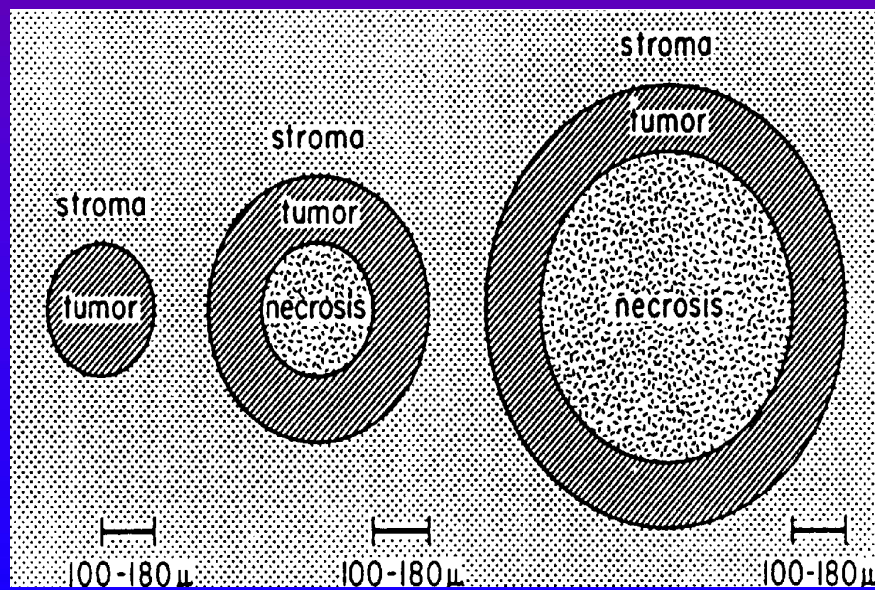



# Radiobiology - essential information

## 4. Redistribution

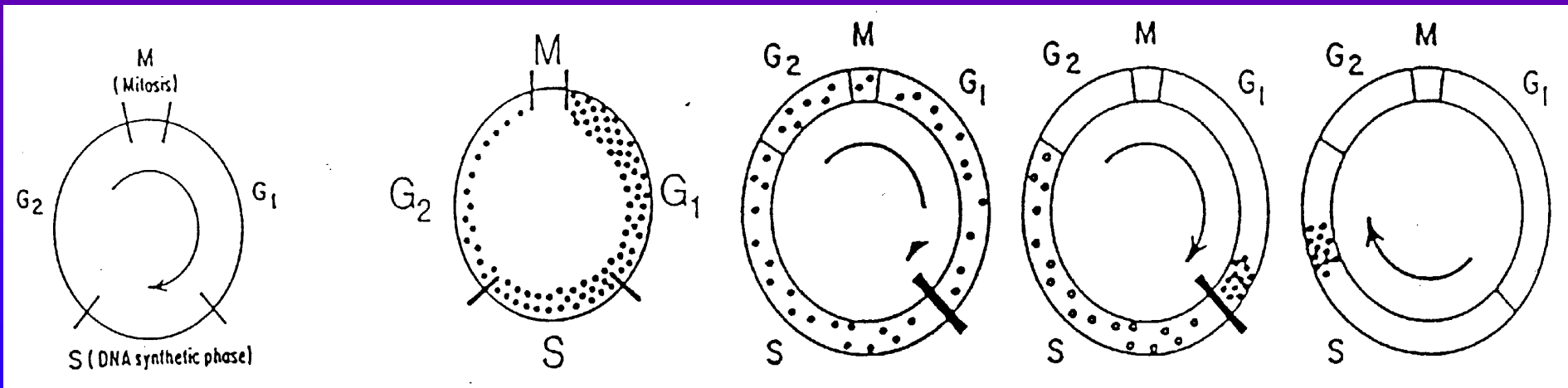

# Normal tissue reactions

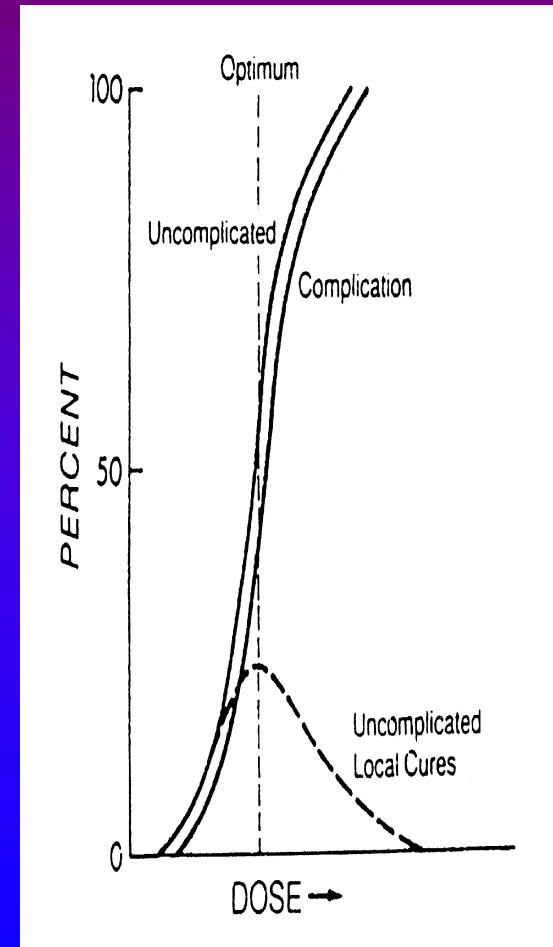
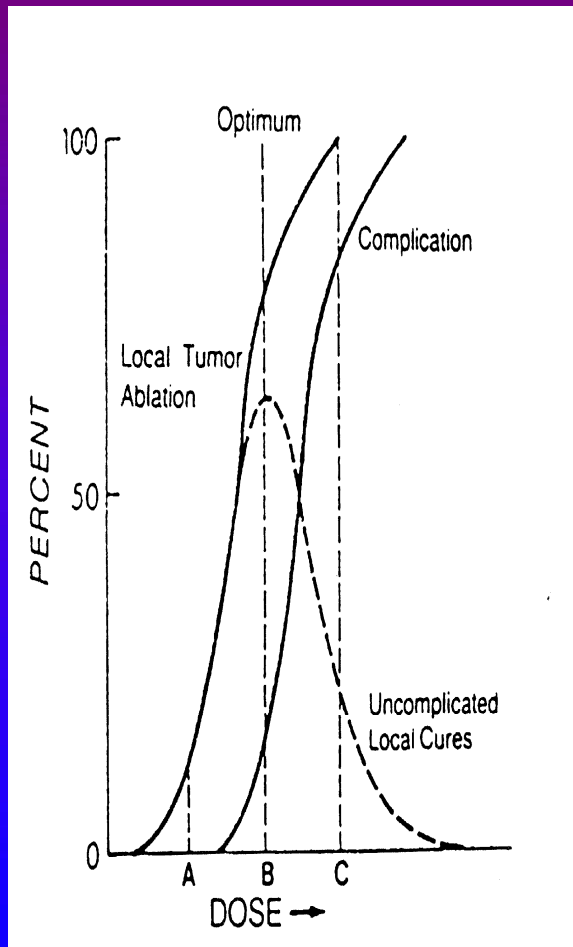

# Demonstration of dose surface from various views (1)

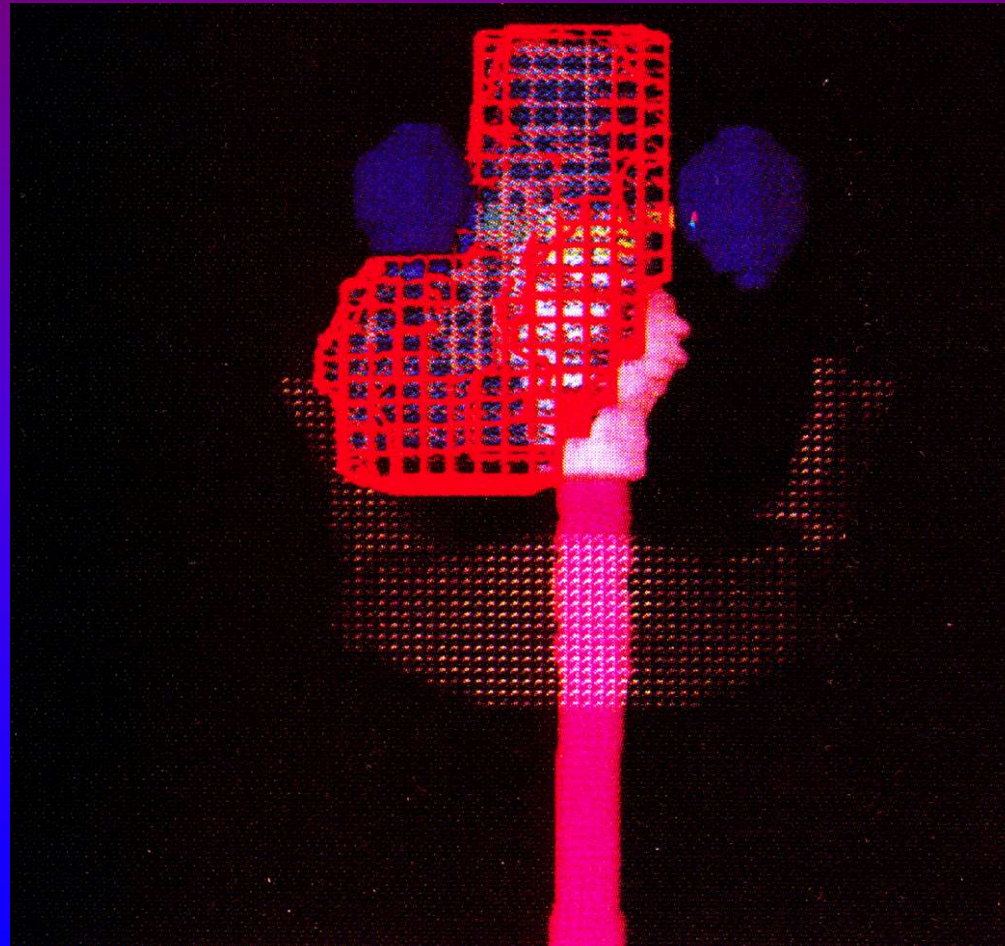

# Demonstration of dose surface from various views (2)

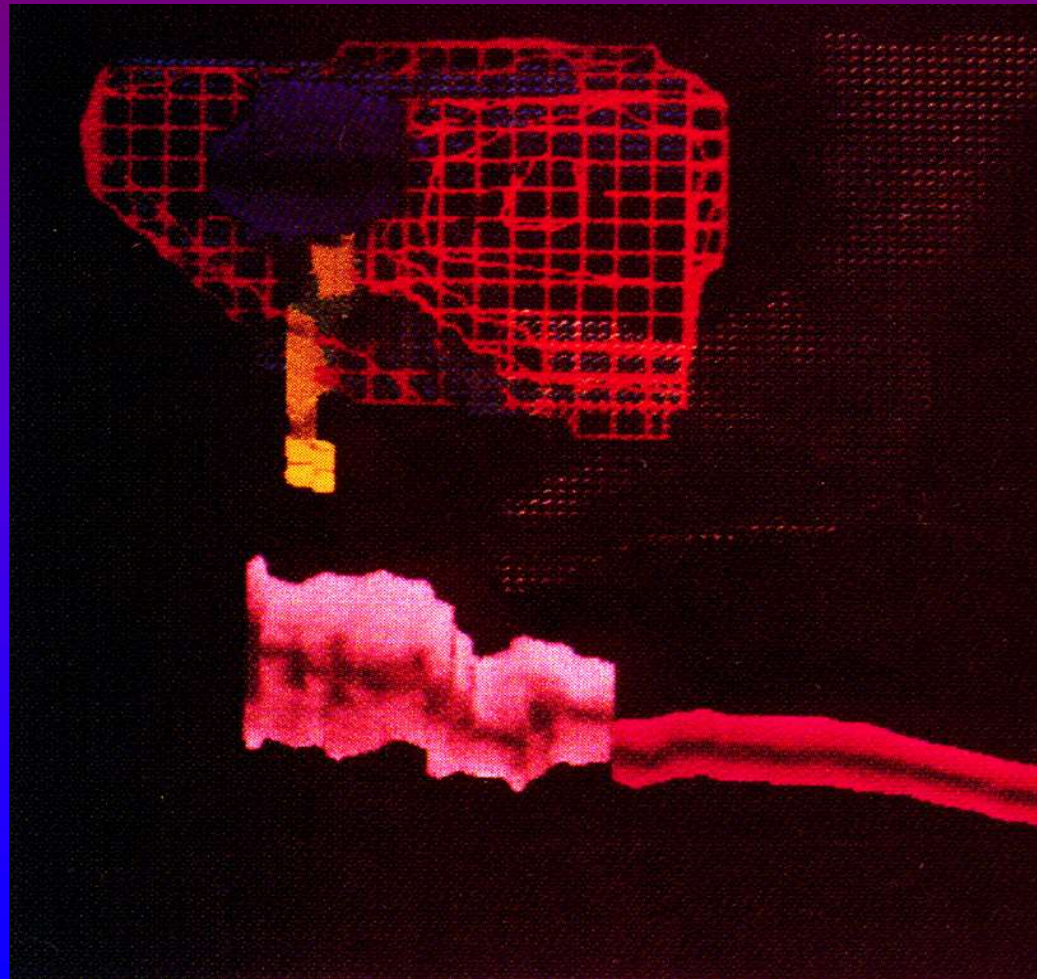

# Demonstration of dose surface from various views (3)

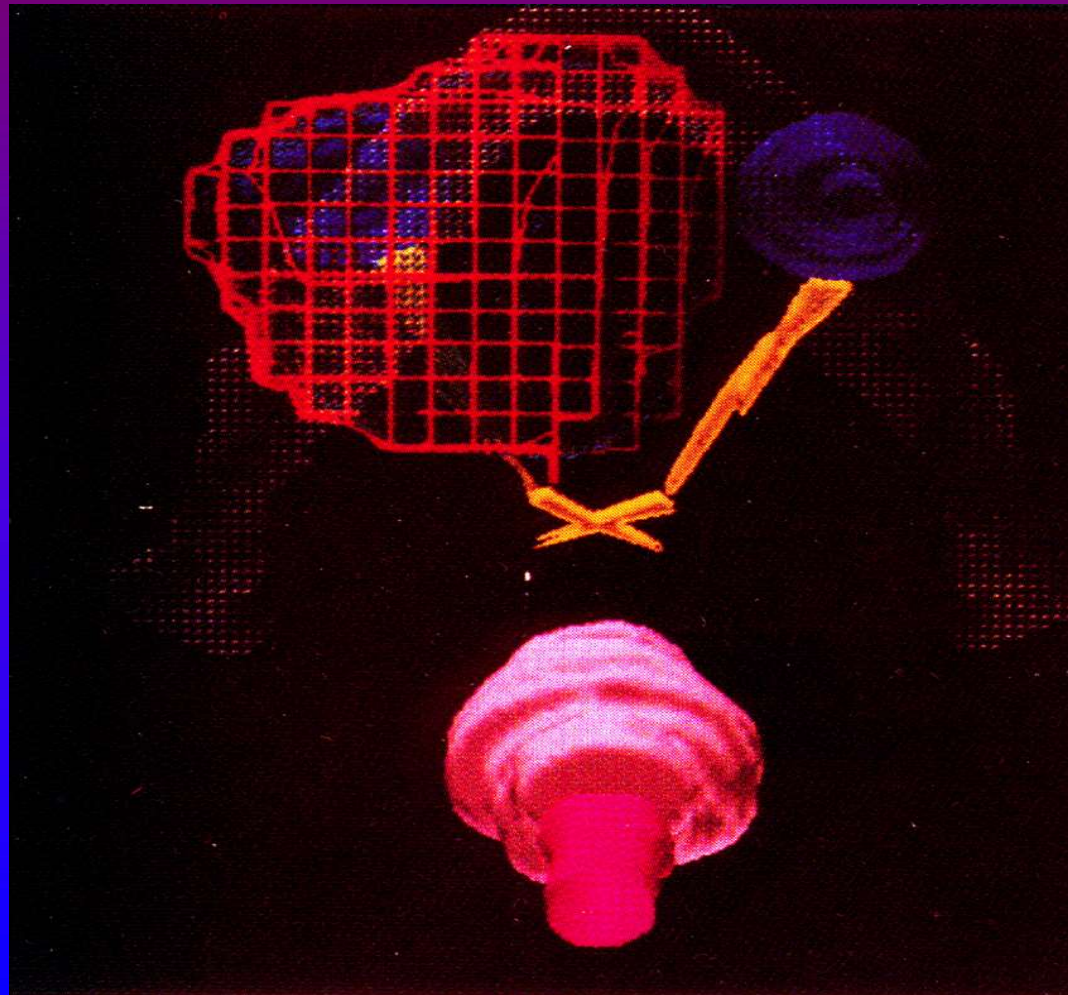

# Demonstration of dose surface from various views (4)

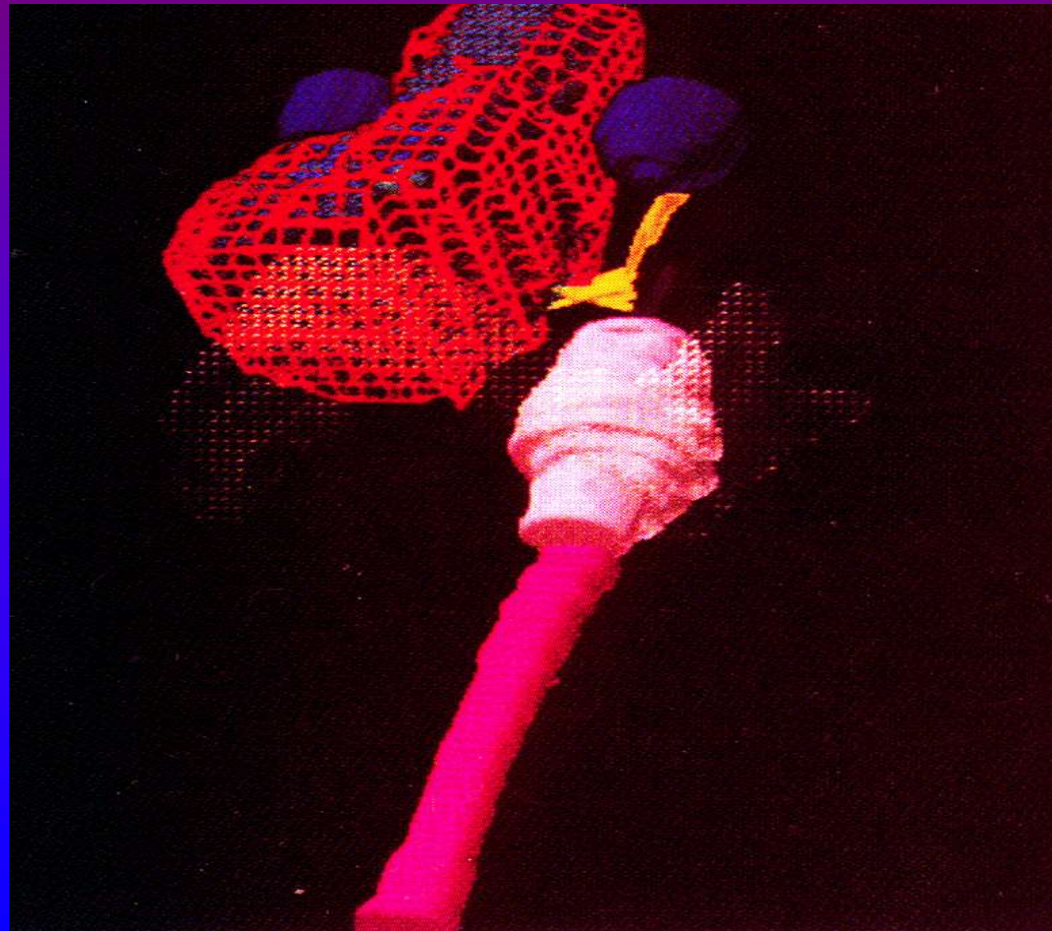

# BRACHYTHERAPY

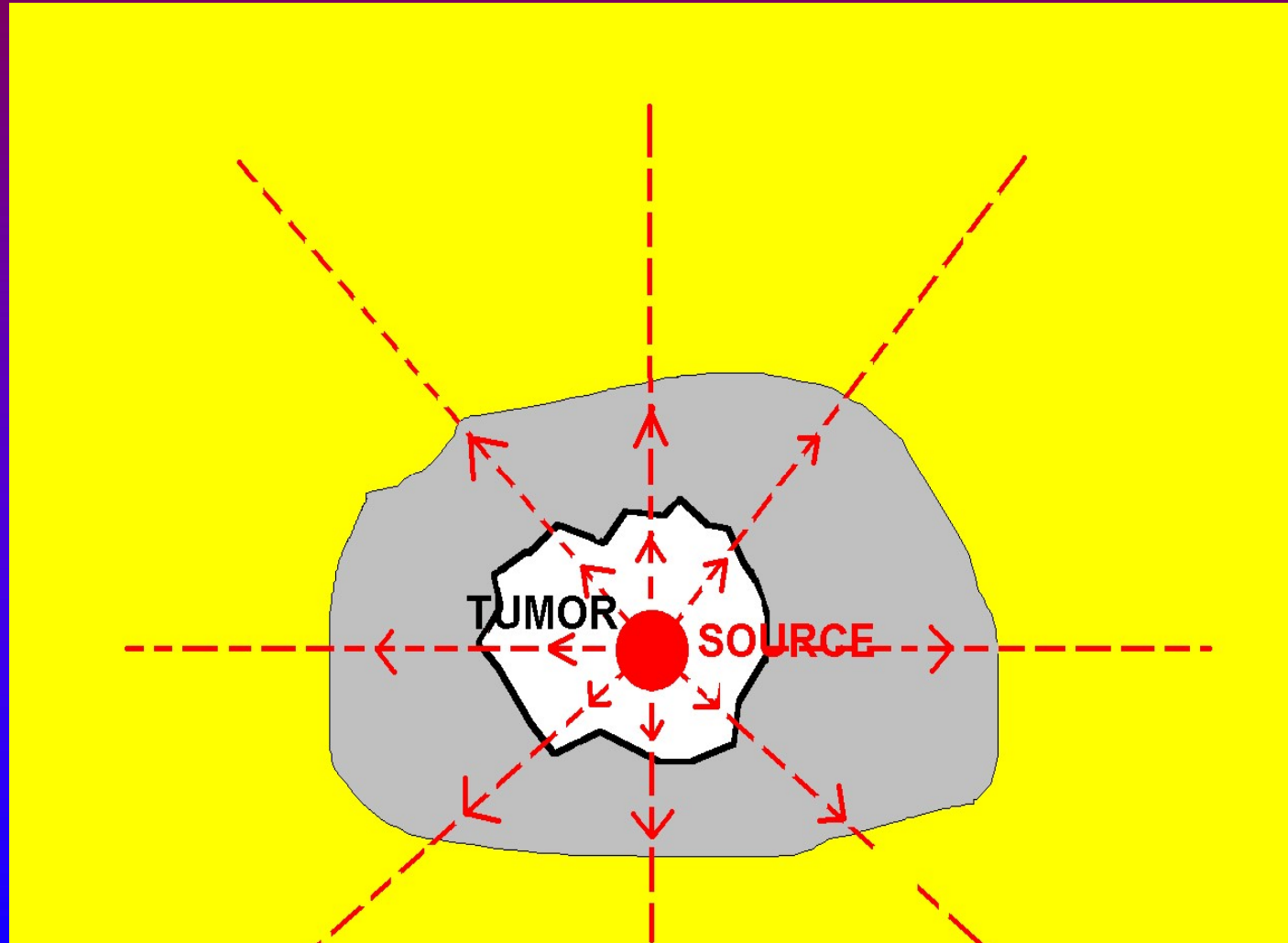

# Klasyczne metody leczenia radem- brachyterapia LDR

sztokholmska

paryska

menczesterska

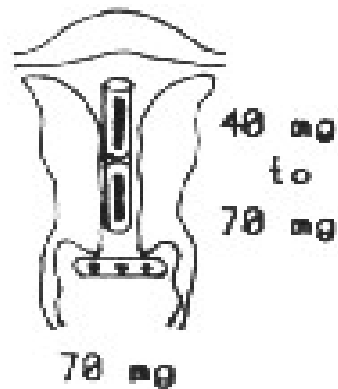

2x1-day  
treatments  
3 weeks apart

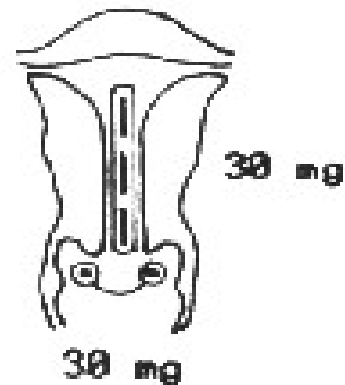

1 5-day  
treatment

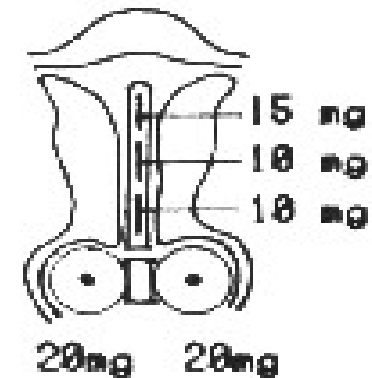

2x3-day  
treatments  
1 week apart



# **IBU: ZINTEGROWANY SYSTEM WERYFIKACJI**

---



# Brachyterapia pooperacyjna

Aplikatory - cylindry waginalne



# Rak endometrium

## brachyterapia samodzielna

### Przykłady aplikatorów



# Rak endometrium brachyterapia samodzielna

Przykład specyfikacji i optymalizacji dawki dla aplikatora w kształcie Y

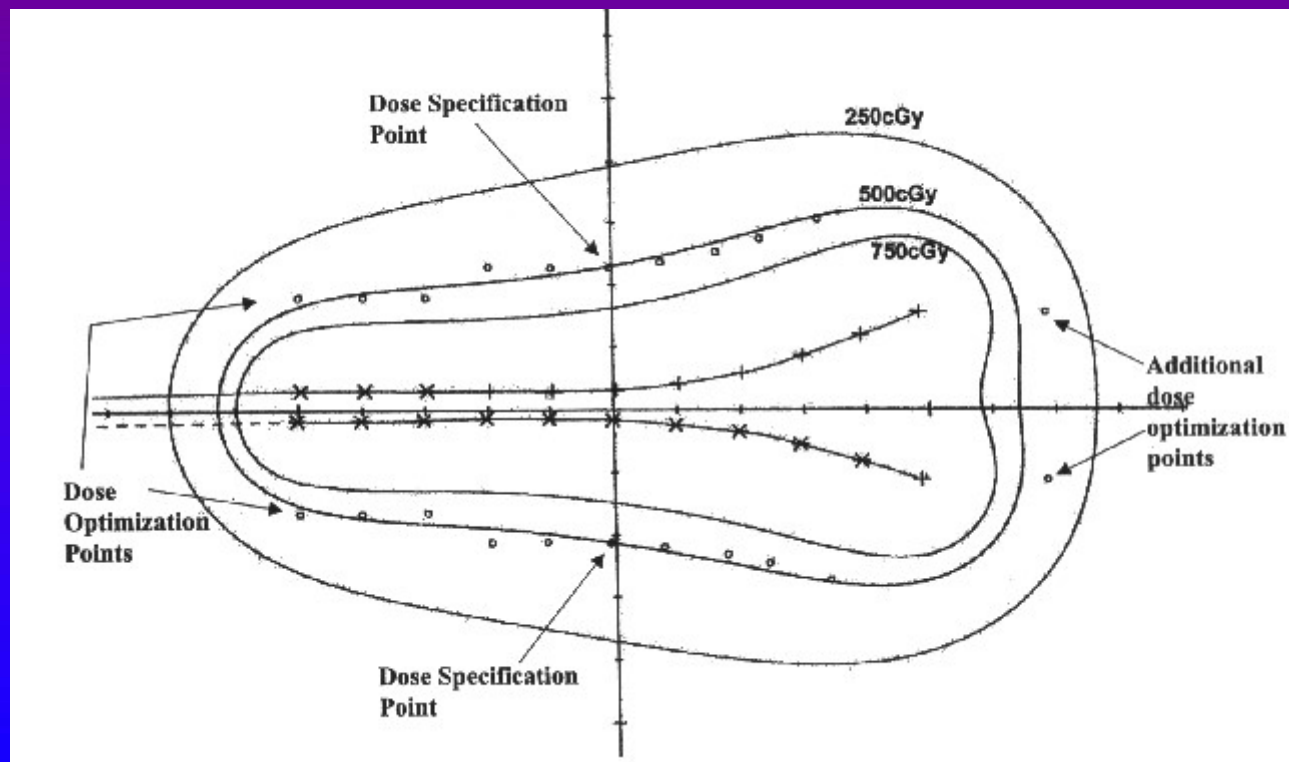

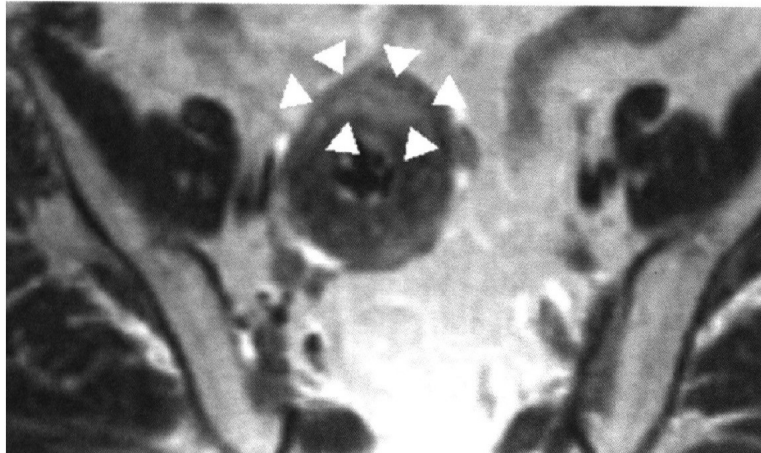
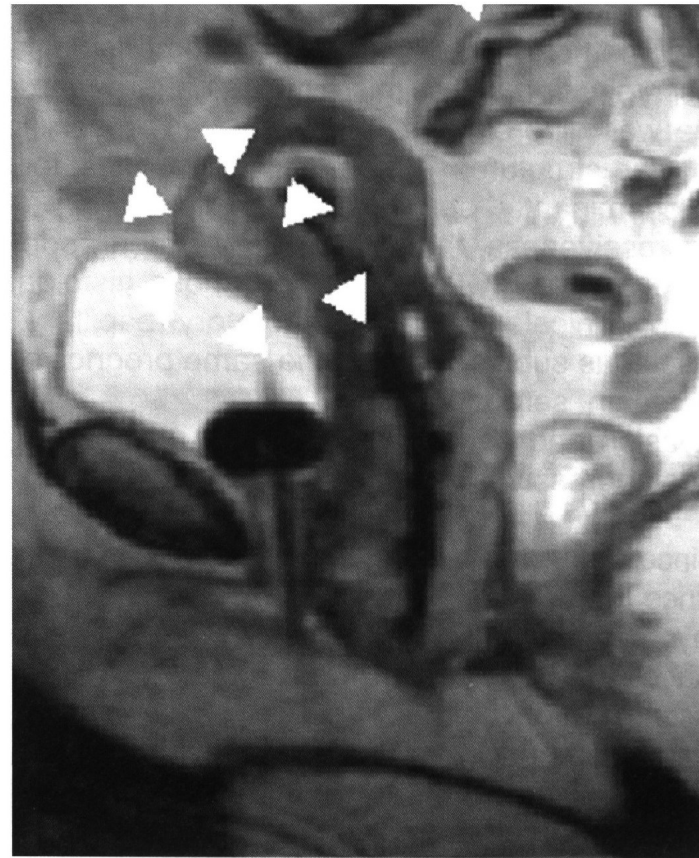
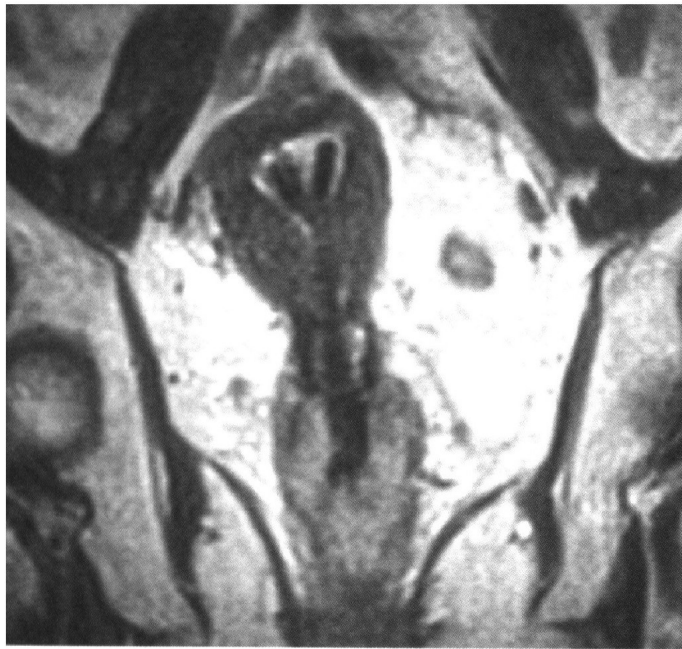

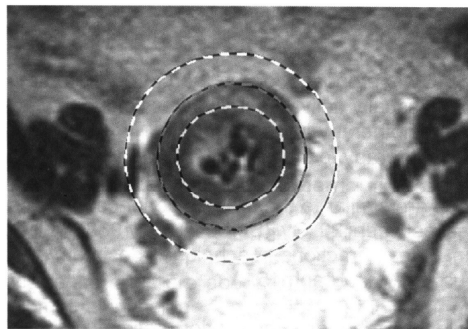
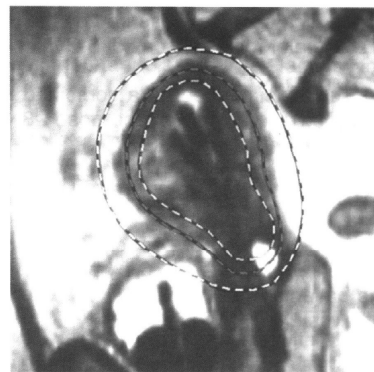
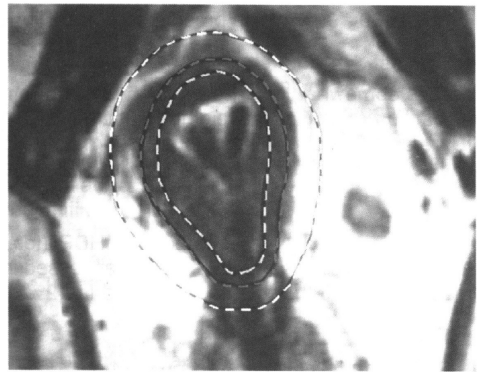
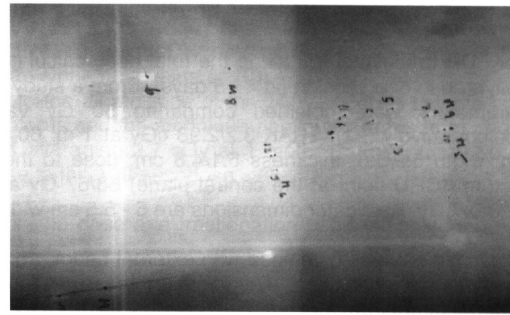
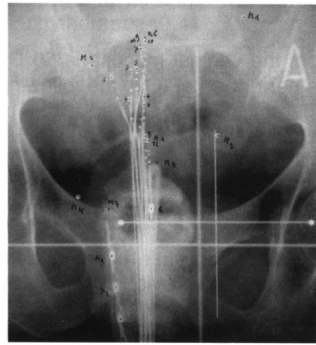



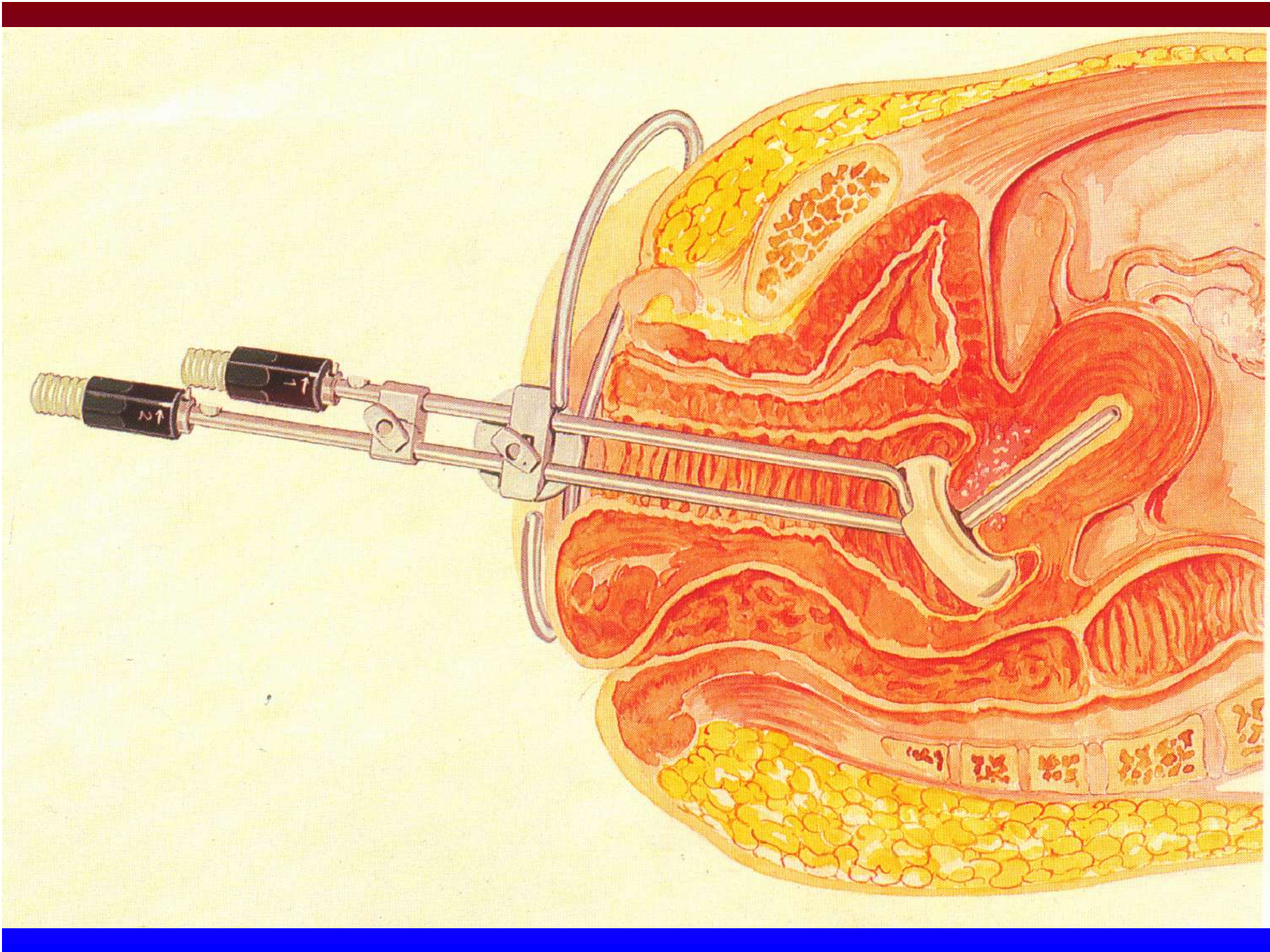



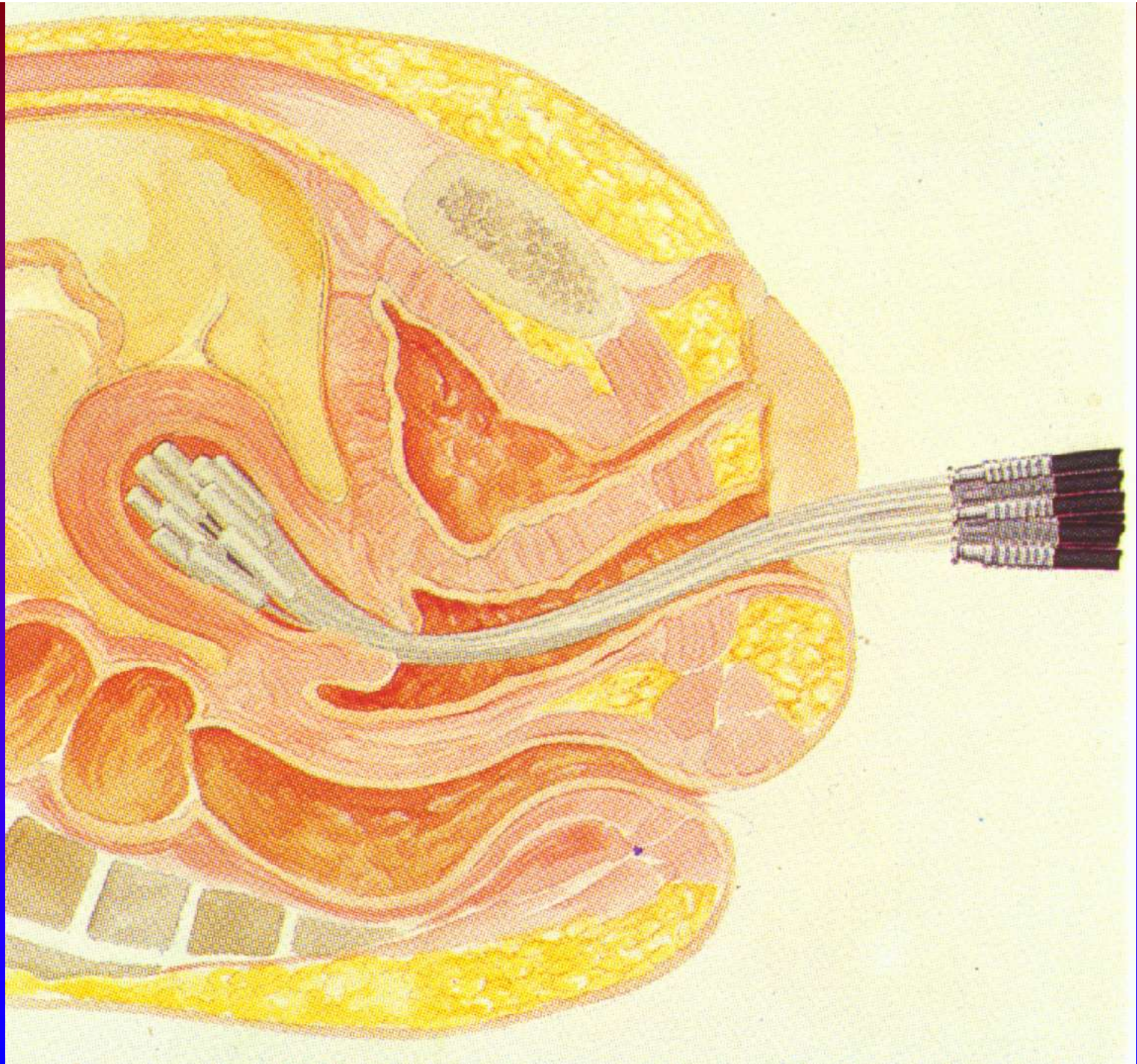

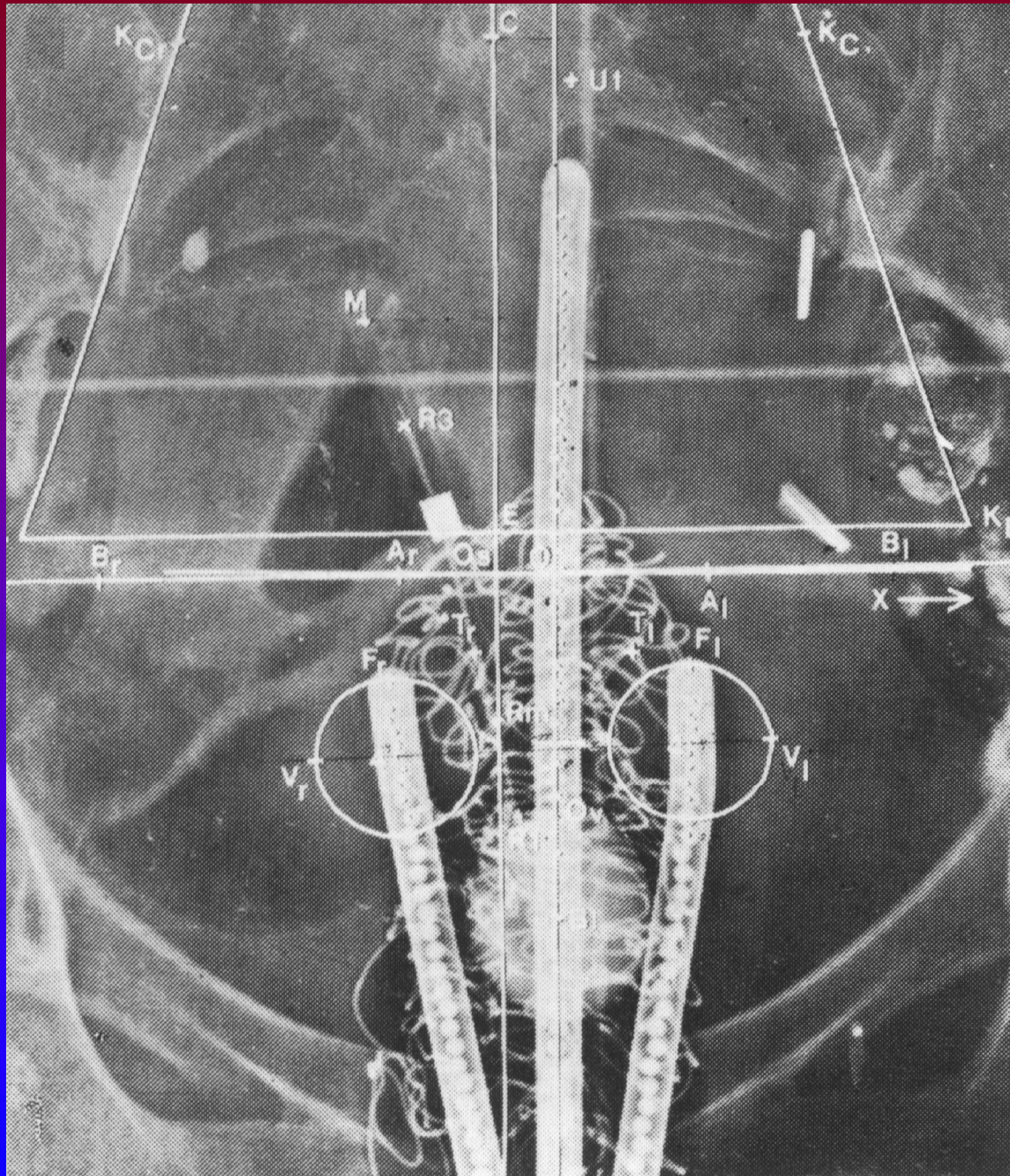

H

H

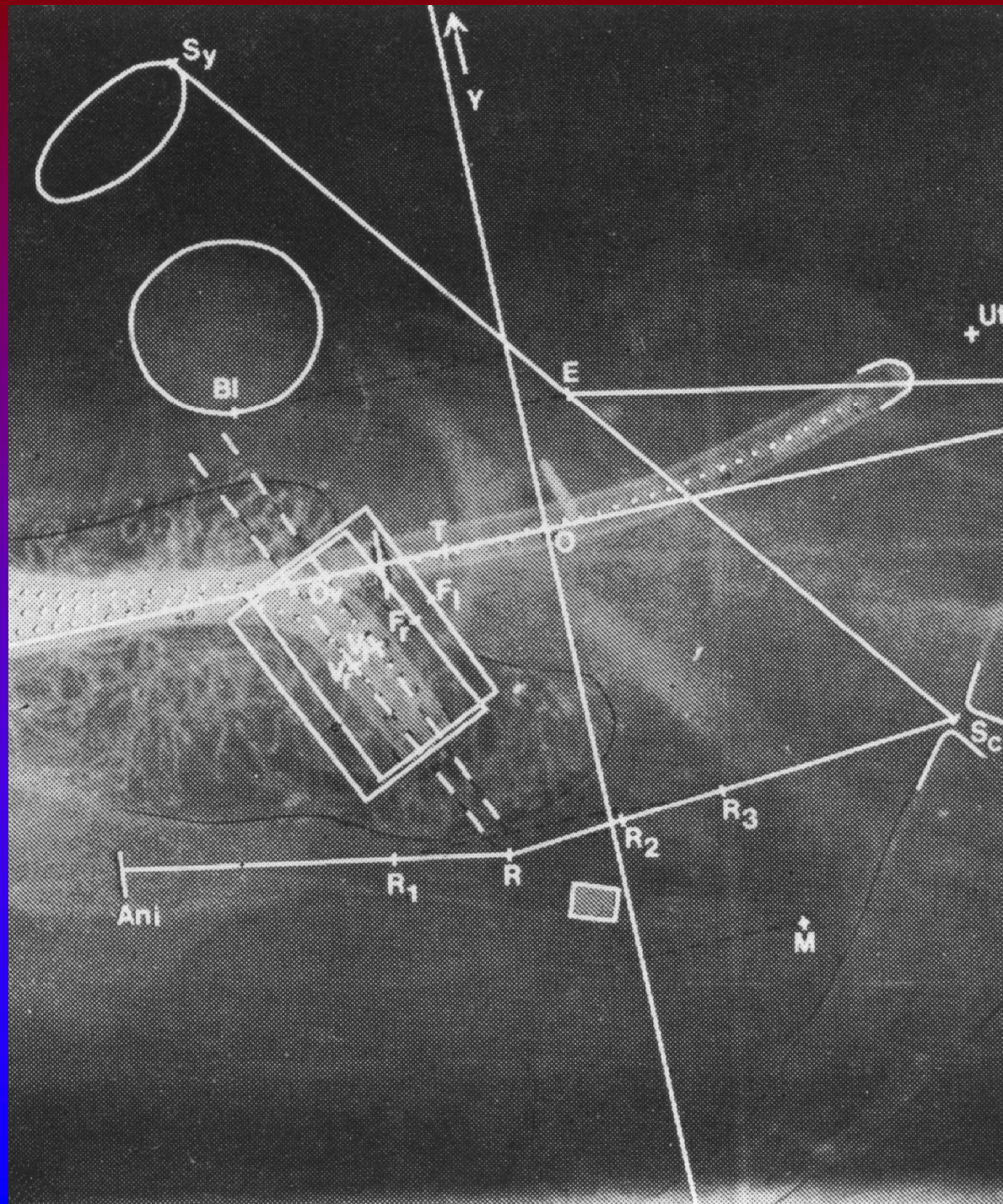

# ROZKŁAD IZODOZOWY SONDA 2S, 5.5 cm

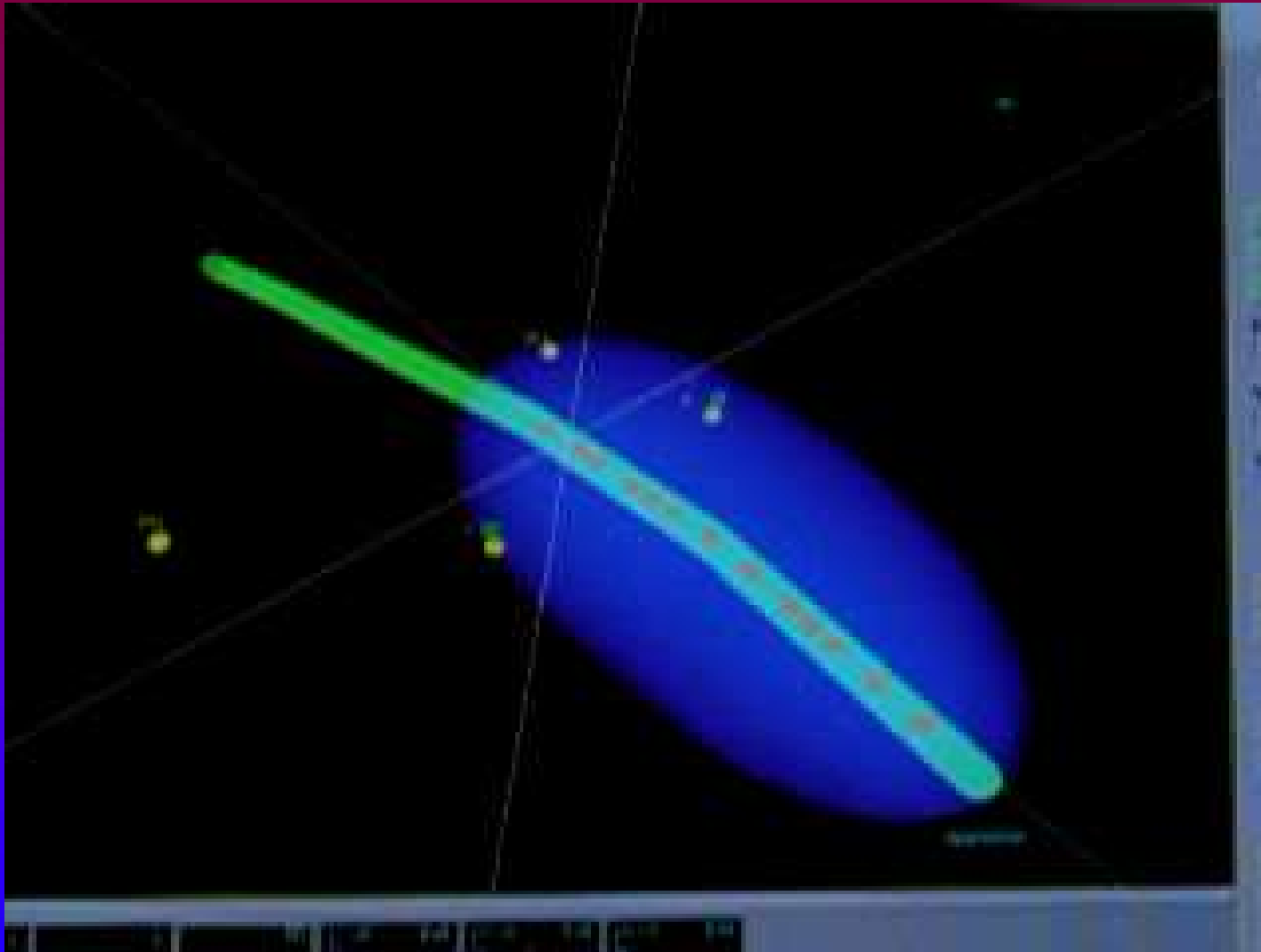

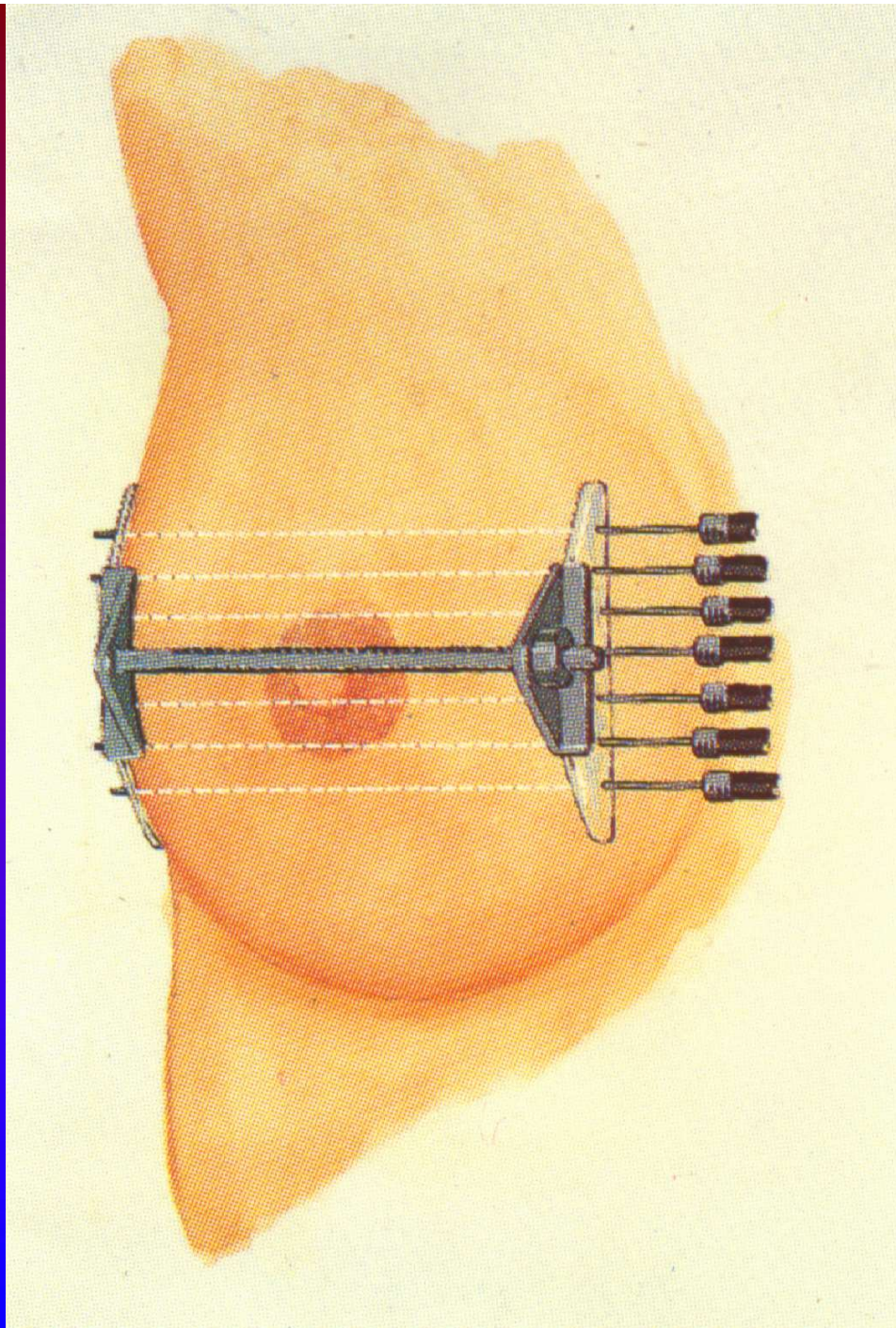

**HDR**

# HDR Ir-192

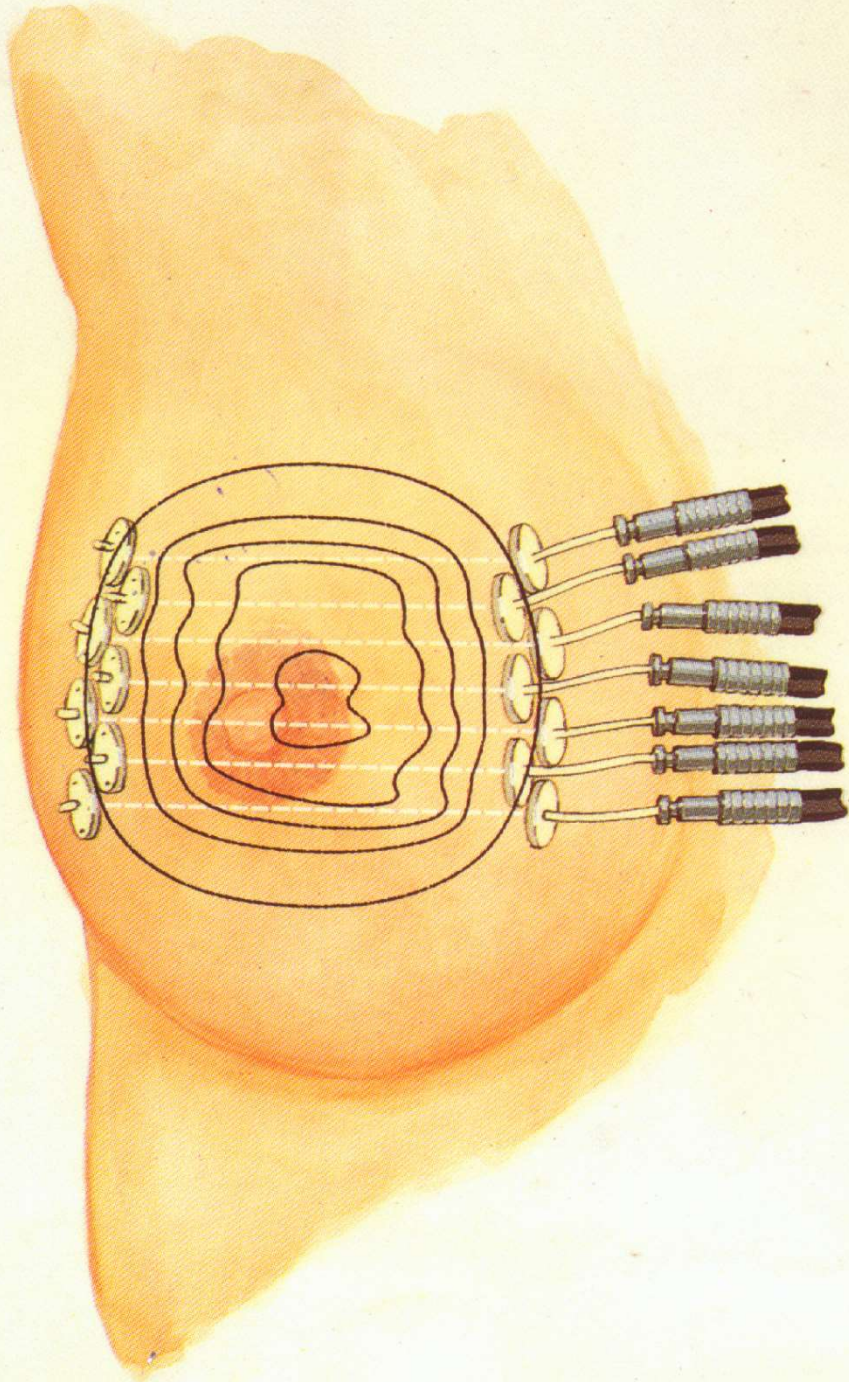



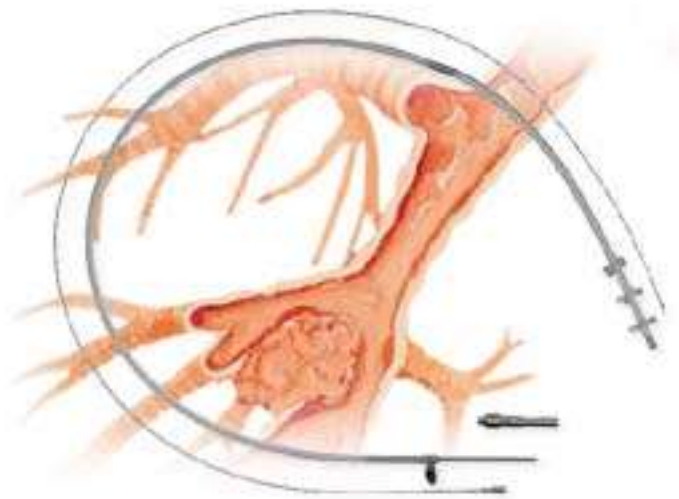



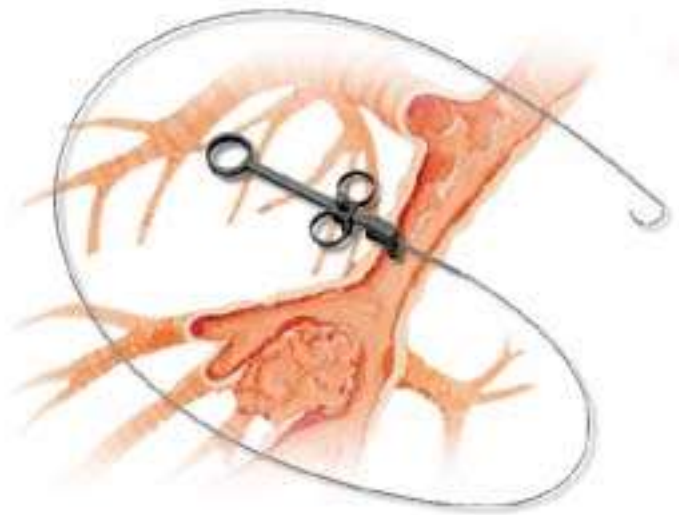

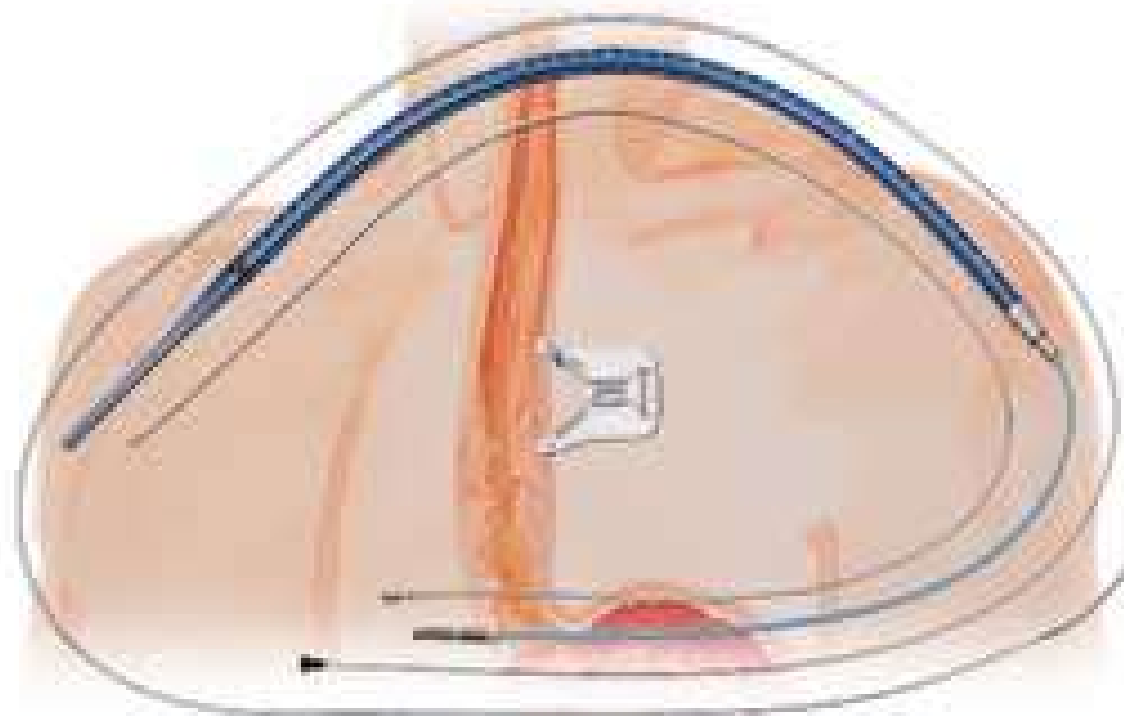



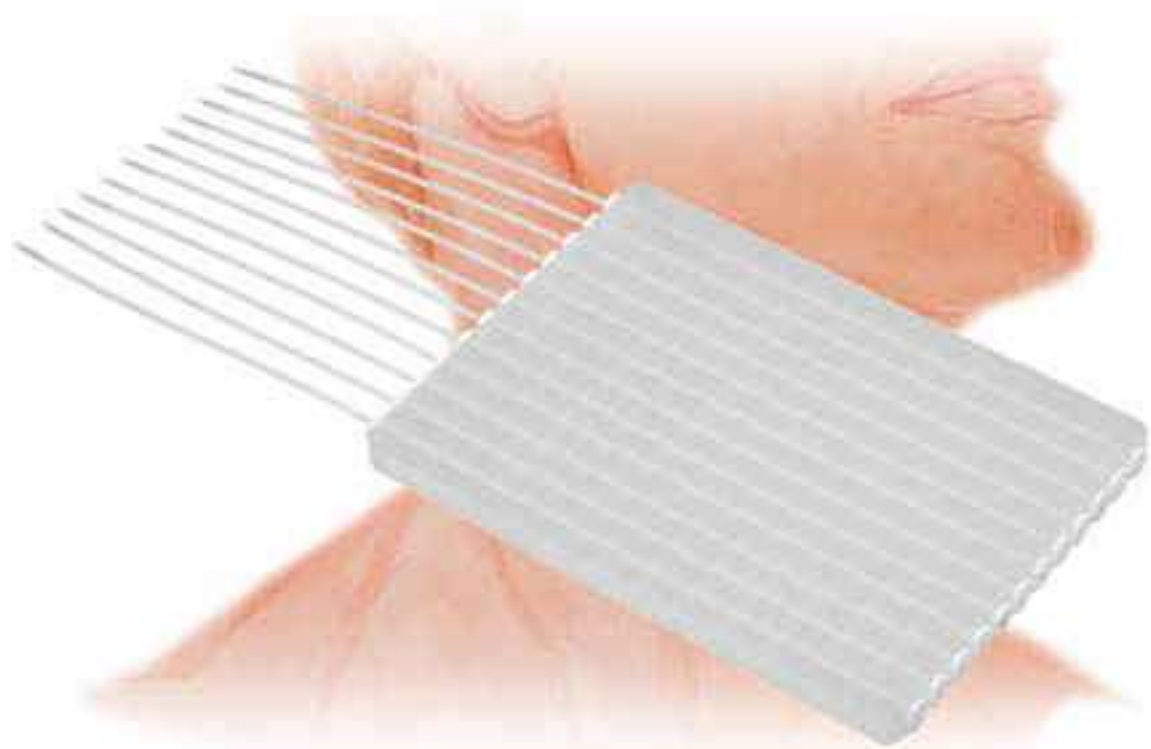

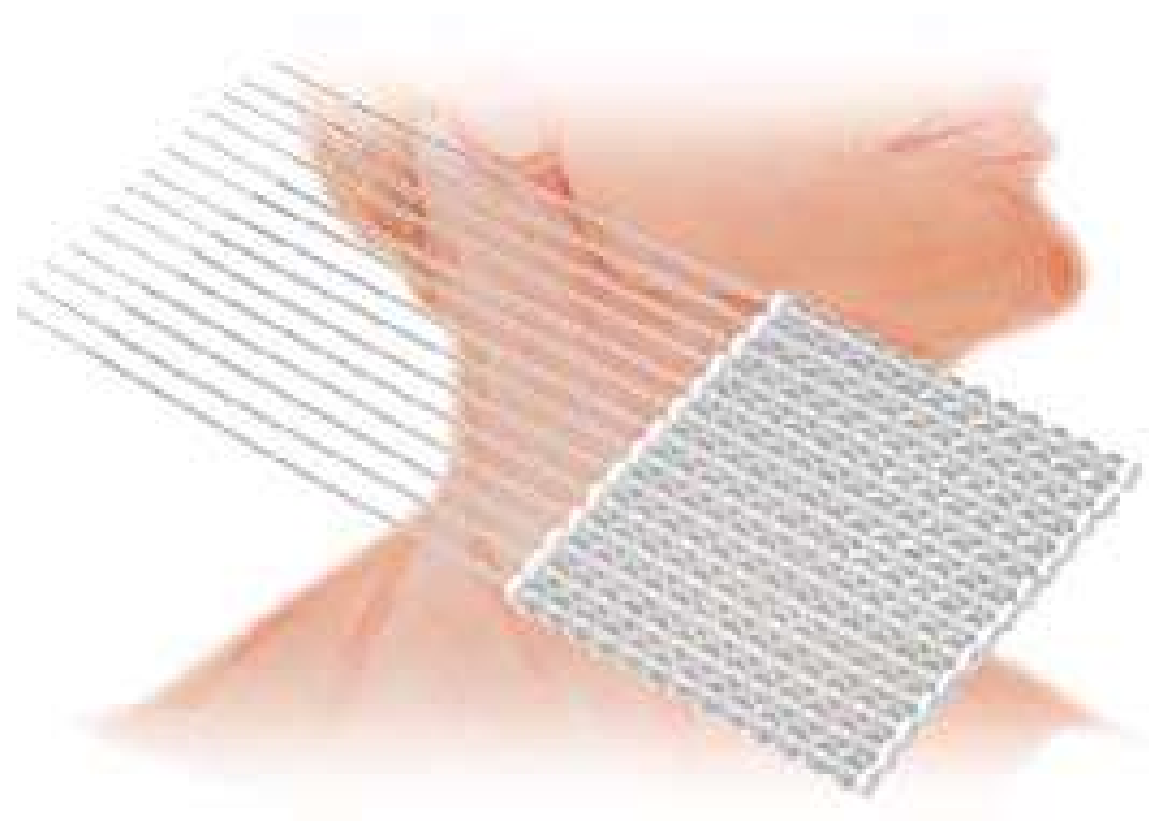



# Normal tissue reactions

